



Kraftfahrt-Bundesamt

DE-24932 Flensburg

Allgemeine Betriebserlaubnis (ABE) National Type Approval

ausgestellt von:

Kraftfahrt-Bundesamt (KBA)

nach § 22 in Verbindung mit § 20 Straßenverkehrs-Zulassungs-Ordnung (StVZO)
für einen Typ des folgenden Genehmigungsobjektes

Windschild

issued by:

Kraftfahrt-Bundesamt (KBA)

according to § 22 and 20 Straßenverkehrs-Zulassungs-Ordnung (StVZO) for a type
of the following approval object

windshield

Genehmigungsnummer: **30227*30**

Approval number:

1. Genehmigungsinhaber:
Holder of the approval:
Fechter Drive Motorsport GmbH
DE-73235 Weilheim/Teck
2. Gegebenenfalls Name und Anschrift des Bevollmächtigten:
If applicable, name and address of representative:
Entfällt
Not applicable
3. Typbezeichnung:
Type:
100



Kraftfahrt-Bundesamt

DE-24932 Flensburg

2

Genehmigungsnummer: **30227*30**

Approval number:

4. Aufgebrachte Kennzeichnungen:
Identification markings:
Hersteller oder Herstellerzeichen
Manufacturer or registered manufacturer's trademark

Typ
Type

Genehmigungszeichen
Approval identification

5. Anbringungsstelle der Kennzeichnungen:
Position of the identification markings:
Siehe Punkt 1.6 des Prüfberichtes
See point 1.6 of the test report

6. Zuständiger Technischer Dienst:
Responsible Technical Service:
TÜV SÜD Auto Service GmbH
DE-80686 München

7. Datum des Prüfberichts des Technischen Dienstes:
Date of test report issued by the Technical Service:
18.11.2022

8. Nummer des Prüfberichts des Technischen Dienstes:
Number of test report issued by that Technical Service:
11-00086-CM-GBM-30

9. Verwendungsbereich:
Range of application:
Das Genehmigungsobjekt „Windschild“ darf nur zur Verwendung gemäß:
The use of the approval object „windshield“ is restricted to the application listed:

Punkt 3. des Prüfberichtes
Point 3. of the test report

unter den angegebenen Bedingungen an den dort aufgeführten bzw. beschriebenen Kraftfahrzeugen feilgeboten werden.
The offer for sale is only allowed on the listed vehicles under the specified conditions.



Kraftfahrt-Bundesamt

DE-24932 Flensburg

3

Genehmigungsnummer: **30227*30**

Approval number:

10. Bemerkungen:

Remarks:

**Es gelten die im o.g. Gutachten nebst Anlagen festgehaltenen Angaben.
The indications given in the above mentioned test report including its annexes shall apply.**

**Die Anforderungen des Artikels 51, Absätze 1, 2, 4, 5 der Verordnung (EU) Nr. 168/2013 - Teile oder Ausrüstungen, von denen ein erhebliches Risiko für das einwandfreie Funktionieren wesentlicher Systeme ausgehen kann - weitere Anforderungen - sind sinngemäß erfüllt.
The requirements of Article 51, paragraphs 1, 2, 4, 5 of the Regulation (EU) No 168/2013 - Parts or equipment that may pose a serious risk to the correct functioning of essential systems - related requirements - are met.**

11. Änderungsabnahme gemäß § 19 (3) StVZO:

Acceptance test of the modification as per § 19 (3) StVZO:

**Nicht notwendig
Not required**

12. Die Genehmigung wird **erweitert**

Approval is **extended**

13. Grund (Gründe) für die Erweiterung der Genehmigung (falls zutreffend):

Reason(s) for the extension (if applicable):

**Aktualisierung des Verwendungsbereichs
Update of the range of application**

**Aktualisierung der Ausführungen
Update of the variants**

14. Ort: **DE-24932 Flensburg**

Place:

15. Datum: **28.12.2022**

Date:

16. Unterschrift: **Im Auftrag**

Signature:

Nino Pommerencke





Kraftfahrt-Bundesamt

DE-24932 Flensburg

4

Genehmigungsnummer: **30227*30**

Approval number:

Anlagen:

Enclosures:

Gemäß Inhaltsverzeichnis

According to index



Kraftfahrt-Bundesamt

DE-24932 Flensburg

Inhaltsverzeichnis zu den Beschreibungsunterlagen Index to the information package

Nummer der Genehmigung: **30227*30**
Approval No.

Ausgabedatum: **24.11.1994**
Date of issue:

letztes Änderungsdatum: **28.12.2022**
last date of amendment:

Nebenbestimmungen und Rechtsbehelfsbelehrung
Collateral clauses and instruction on right to appeal

Prüfbericht(e) Nr.: Test report(s) No.:	Datum: Date
00 0362 00	07.11.1994
00 0362 01	09.04.1996
00 0362 02	17.04.1997
00 0362 03	13.03.1998
18 10 0362 06	25.01.1999
18 10 0362 07	24.02.2000
18 10 0362 08	19.10.2000
18 10 0362 09	02.03.2001
18 10 0362 10	29.01.2002
18 10 0362 NT12	05.05.2003
18 10 0362 NT13	19.02.2004
18 10 0362 NT14	02.02.2005
18 10 0362 NT15	23.02.2006
18 10 0362 NT16	09.02.2007
08-00506-CP-FIL-17	08.05.2008
08-00506-CP-FIL-18	25.05.2009
08-00506-CP-FIL-19	07.06.2010
11-00086-CM-GBM-19	02.08.2011
11-00086-CM-GBM-20	06.06.2012
11-00086-CM-GBM-21	17.12.2013
11-00086-CM-GBM-22	28.08.2015
11-00086-CM-GBM-23	17.03.2016
11-00086-CM-GBM-24	16.05.2017
11-00086-CM-GBM-25	05.11.2018
11-00086-CM-GBM-26	07.08.2019
11-00086-CM-GBM-27	19.05.2020
11-00086-CM-GBM-28	07.12.2020
11-00086-CM-GBM-29	28.07.2021
11-00086-CM-GBM-30	18.11.2022

Beschreibungsbogen Nr.:
Information document No.:
Entfällt
Not applicable

Datum:
Date



Kraftfahrt-Bundesamt

DE-24932 Flensburg

2

Nummer der Genehmigung: **30227*30**
Approval No.

Liste der Änderungen:

List of modifications:

Siehe Punkt 0. des Prüfberichtes

See point 0. of the technical report

Datum:

Date



Kraftfahrt-Bundesamt

DE-24932 Flensburg

Nummer der Genehmigung: **30227*30**

- Anlage -

Nebenbestimmungen und Rechtsbehelfsbelehrung

Nebenbestimmungen

Jede Einrichtung, die dem genehmigten Typ entspricht, ist gemäß der angewendeten Vorschrift zu kennzeichnen.

Das Genehmigungszeichen lautet wie folgt:

KBA 30227

Die Einzelerzeugnisse der reihenweisen Fertigung müssen mit den Genehmigungsunterlagen genau übereinstimmen. Änderungen an den Einzelerzeugnissen sind nur mit ausdrücklicher Zustimmung des Kraftfahrt-Bundesamtes gestattet.

Änderungen der Firmenbezeichnung, der Anschrift und der Fertigungsstätten sowie eines bei der Erteilung der Genehmigung benannten Zustellungsbevollmächtigten oder bevollmächtigten Vertreters sind dem Kraftfahrt-Bundesamt unverzüglich mitzuteilen.

Verstöße gegen diese Bestimmungen können zum Widerruf der Genehmigung führen und können überdies strafrechtlich verfolgt werden.

Die Genehmigung erlischt, wenn sie zurückgegeben oder entzogen wird, oder der genehmigte Typ den Rechtsvorschriften nicht mehr entspricht. Der Widerruf kann ausgesprochen werden, wenn die für die Erteilung und den Bestand der Genehmigung geforderten Voraussetzungen nicht mehr bestehen, wenn der Genehmigungsinhaber gegen die mit der Genehmigung verbundenen Pflichten - auch soweit sie sich aus den zu dieser Genehmigung zugeordneten besonderen Auflagen ergeben - verstößt oder wenn sich herausstellt, dass der genehmigte Typ den Erfordernissen der Verkehrssicherheit oder des Umweltschutzes nicht entspricht.

Das Kraftfahrt-Bundesamt kann jederzeit die ordnungsgemäße Ausübung der durch diese Genehmigung verliehenen Befugnisse, insbesondere die genehmigungsgerechte Fertigung sowie die Maßnahmen zur Übereinstimmung der Produktion, nachprüfen. Es kann zu diesem Zweck Proben entnehmen oder entnehmen lassen. Dem Kraftfahrt-Bundesamt und/oder seinen Beauftragten ist ungehinderter Zutritt zu Produktions- und Lagerstätten zu gewähren.

Die mit der Erteilung der Genehmigung verliehenen Befugnisse sind nicht übertragbar. Schutzrechte Dritter werden durch diese Genehmigung nicht berührt.

Rechtsbehelfsbelehrung

Gegen diese Genehmigung kann innerhalb eines Monats nach Bekanntgabe Widerspruch erhoben werden. Der Widerspruch ist beim **Kraftfahrt-Bundesamt, Fördestraße 16, DE-24944 Flensburg**, schriftlich oder zur Niederschrift einzulegen.



Kraftfahrt-Bundesamt

DE-24932 Flensburg

2

Approval No.: **30227*30**

- Attachment -

Collateral clauses and instruction on right to appeal

Collateral clauses

All equipment which corresponds to the approved type is to be identified according to the applied regulation.

The approval identification is as follows: - see German version -

The individual production of serial fabrication must be in exact accordance with the approval documents. Changes in the individual production are only allowed with express consent of the Kraftfahrt-Bundesamt.

Changes in the name of the company, the address and the manufacturing plant as well as one of the parties given the authority to delivery or authorised representative named when the approval was granted is to be immediately disclosed to the Kraftfahrt-Bundesamt.

Breach of this regulation can lead to recall of the approval and moreover can be legally prosecuted.

The approval expires if it is returned or withdrawn or if the type approved no longer complies with the legal requirements. The revocation can be made if the demanded requirements for issuance and the continuance of the approval no longer exist, if the holder of the approval violates the duties involved in the approval, also to the extent that they result from the assigned conditions to this approval, or if it is determined that the approved type does not comply with the requirements of traffic safety or environmental protection.

The Kraftfahrt-Bundesamt may check the proper exercise of the conferred authority taken from this approval at any time. In particular this means the compliant production as well as the measures for conformity of production. For this purpose samples can be taken or have taken. The employees or the representatives of the Kraftfahrt-Bundesamt may get unhindered access to the production and storage facilities.

The conferred authority contained with issuance of this approval is not transferable. Trade mark rights of third parties are not affected with this approval.

Instruction on right to appeal

This approval can be appealed within one month after notification. The appeal is to be filed in writing or as a transcript at the **Kraftfahrt-Bundesamt, Fördestraße 16, DE-24944 Flensburg.**

Techn.Bericht Nr. /
Techn. Report No.: 11-00086-CM-GBM-30
Hersteller / *Manufacturer:* Fechter-Drive Motorsport GmbH
Art / *Kind /* Windschild / *Windshield*
Typ / *Type* 100

Seite/Page 1/4

**Gutachten zur Erteilung einer
Allgemeinen Betriebserlaubnis nach § 22 StVZO
Technical report
for German type approval regarding § 22 StVZO**

Genehmigungsstand / Approval status	
<input type="checkbox"/>	Erteilung einer Typgenehmigung <i>Granting of a type approval</i>
<input checked="" type="checkbox"/>	Nachtrag/Änderung zur Typgenehmigung Nr. ABE Nr. KBA 30227 <i>Extension/correction to type approval no.</i>

0. Gründe der Erweiterung / Reasons for extension

Es wird geändert: <i>It will be changed:</i>	neue Ausführungen kommen hinzu <i>new variants added</i>
Es wird aktualisiert: <i>It will be updated:</i>	der Verwendungsbereich <i>the application list is extended</i>

1. Allgemeine Angaben / General Information

- | | | |
|-----|---|--|
| 1.1 | Hersteller / <i>Manufacturer:</i> | Fechter-Drive Motorsport GmbH
Michael-Becker-Str. 22
73235 Weilheim |
| 1.2 | Produktionsstätte /
<i>Producer</i> | Ermax International
1074 Av. des Carrières
Z.A. La Plaine Du Caire III
F-13830 Roquefort la Bédoule |
| 1.3 | Art / <i>Kind:</i> | Windschild zum Anbau an Krafträder /
<i>Aftermarket windshield for mounting on motorcycles</i> |
| 1.4 | Typ / <i>Type</i>
Ausführungen / <i>Versions</i> | 100
siehe Anlage 6.1 / <i>notice enclosure 6.1</i> |
| 1.5 | Handelsmarke / <i>Trade name</i> | Ermax |
| 1.6 | Kennzeichnung / <i>Marking</i> | Typ / Handelsmarke <i>Type / Trade name</i>
KBA 30227 |
| | Art der Kennzeichnung
<i>Kind of marking</i> | selbstzerstörender Aufkleber
<i>self destructive sticker</i> |
| | Ort der Kennzeichnung
<i>Place of marking</i> | seitlich rechts
<i>on the right side</i> |

Techn.Bericht Nr. /
Techn. Report No.: 11-00086-CM-GBM-30
Hersteller / *Manufacturer:* Fechter-Drive Motorsport GmbH
Art / *Kind /* Windschild / *Windshield*
Typ / *Type* 100

Seite/Page 2/4

1.7 Beschreibung der Teile siehe Anlage 6.2 und 6.3
Description of parts notice encl. 6.2 and 6.3
Auf Grund des Fertigungsverfahrens existieren keine technischen Zeichnungen.
Die Fotodokumentation wird als ausreichend erachtet. Zur Rückführbarkeit auf die
Prüfmuster hält der Hersteller jeweils ein Master Sample vor.
Due to the production process there are no technical drawings available.
The photo documentation will be sufficient. For traceability on the test samples, the
manufacturer keeps a master sample for every homologated part available.

1.8 Werkstoff / Glasähnlicher Kunststoff, wahlweise eingefärbt
Material: translucent plastic, optional coloured
Handelsmarke / *brand name:* Altulex choc spezial,
Hersteller / *Manufacturer:* Altulox, Argentueil (F)

2. Durchgeführte Prüfungen / *Performed tests*

Prüfungen gemäß VdTÜV- Merkblatt Nr. 736 von 08.2009 /
Tests regarding VdTÜV- Guideline No. 736 dated 08.2009

- 2.1. Materialprüfung / Bruch- und Splitterverhalten nach
Material test: StVZO TA Nr. 29, Pkt. 3.6.8. /
Breaking- and splinter behavior according to the
German requirement
StVZO TA No. 29, Point. 3.6.8
- 2.2 Massen u. Abmessungen/ gemäß VO44/2014 Anh. XI, keine Auswirkung
Masses a. dimensions auf die Gesamtmasse in erheblichem Maße
(max. 1,5 kg)
According to VO44/2014 Annex 11, no effect on the
total mass to a considerable extent (max 1.5 kg)
- 2.3 Äußere Gestaltung / Gemäß 97/24/EG Kapitel 3, VO 44/2014 Anh. VIII;
External design: i. d. Fassung VO 2016/1824
Die Teile sind mit einem zusätzlichen Kantenschutz
versehen. /
According to 97/24/EG ch. 3; VO 44/2014 Annex VIII
amendment VO 2016/1824. Parts are equipped with
an edge protector.
- 2.4 Anbau von lichttechnischen Gemäß 97/24/EG Kapitel 2 i.d.F. 2009/108/EG,
Einrichtungen / 93/92/EWG, 2009/67/EG, VO 3/2014/ Anh. IX
Instalation of lighting
equipment *According to 97/24/EG chapter 2 from 2009/108/EG*
93/92/EWG, 2009/67/EG, VO 3/2014/ Anh. IX

Techn.Bericht Nr. /

Techn. Report No.: 11-00086-CM-GBM-30
Hersteller / Manufacturer: Fechter-Drive Motorsport GmbH
Art / Kind / Windschild / *Windshield*
Typ / Type 100

Seite/Page 3/4

- 2.5 **Bedienteile - Zugänglichkeit /:** *Controls - accessibility* gemäß VdTÜV Merkblatt 736;
VO (EU) 3/2014 Anh. VIII i. d. F. VO (EU) 2016/1824
acc. to VdTÜV Merkblatt 736,
REG (EU) 3/2014 Annex VIII a. a. b. REG (EU) 2016/1824
- 2.6 **Fahrverhalten / Handling:** Mit in der Anlage 6.1 aufgeführten Fahrzeugen wurden exemplarisch Fahrversuche gemäß VO 3/2014 Anh. XIV durchgeführt. Dabei wurden bis zur Höchstgeschwindigkeit der Prüffahrzeuge keine negativen Einflüsse auf das Fahrverhalten festgestellt /
Handling tests were performed regarding VO 3/2014 Anh. XIV with different bikes. There were no negative effects recognized regarding the handling up to top speed
- 2.7 **Höchstgeschwindigkeit/**
Top speed: Die Höchstgeschwindigkeit der im Verwendungsbereich aufgeführten Fahrzeuge ändert sich außerhalb der Messtoleranz nicht /
The top speed of the vehicles remains the same within the measurement tolerance.
- 2.8 **Anbau / Installation:** Der Anbau erfolgt mit den Original-Befestigungsteilen an den serienmäßigen Befestigungspunkten. Erforderliche Bohrungen sind in den Austauschteilen vorhanden. Falls erforderlich, werden Befestigungsteile mitgeliefert /
The aftermarket parts are installed with original fixing parts at the original fixing points. The aftermarket parts have all necessary fixing holes. Fixing parts are supplied if necessary.
- 2.9 **Sichtfeld über Windschild /**
Visibility over windshield: gemäß VdTÜV-Merkblatt 736 /
According to VdTÜV-Guideline No. 736

3. **Verwendungsbereich / Application list**

siehe Anlage / *notice enclosure:* 6.1

4. **Prüfergebnis / Test result**

Die in Anlage 6.1 aufgeführten Windschilder wurden gemäß den unter Punkt 2 genannten Prüfungen getestet.
Die Teile erfüllen die in den Prüfgrundlagen genannten Anforderungen.

Techn.Bericht Nr. /
Techn. Report No.: 11-00086-CM-GBM-30
Hersteller / *Manufacturer:* Fechter-Drive Motorsport GmbH
Art / *Kind /* Windschild / *Windshield*
Typ / *Type* 100

Seite/Page 4/4

The windshields listed in enclosure 6.1 were tested regarding the tests mentioned in item 2.

The parts comply with the requests of the directives and requirements.

5. Schlussbescheinigung / Summary

Die Abnahme der Anbauteile durch einen amtlich anerkannten Sachverständigen nach § 19.3 StVZO wird nicht für erforderlich gehalten.

An Fahrzeugen -im Verwendungsbereich- mit Einzelzulassung (EBE) muss nach §19(3) StVZO eine Anbauabnahme durchgeführt werden.

Das Gutachten verliert seine Gültigkeit bei technischen Änderungen am Fahrzeugteil oder wenn vorgenommene Änderungen an den im Verwendungsbereich beschriebenen Fahrzeugtypen die Verwendung des Teils beeinflussen, sowie bei Änderung der gesetzlichen Grundlagen.

Der Prüfbericht darf nur vom Auftraggeber und nur in vollem Wortlaut vervielfältigt und weitergegeben werden. Eine auszugsweise Vervielfältigung und Veröffentlichung des Prüfberichtes ist nur nach schriftlicher Genehmigung des Prüflaboratoriums zulässig
A check of the installation by an official recognised expert according to §19(3) StVZO is not necessary.

The installation on vehicles with single type approval must be checked separately.

The approval loses validity in case of:

- *modification of the technical unit*
- *changes on the vehicles described in the application list, which affect the usage of the technical unit*
- *changes in the testing directives and requirements*

The test report may be reproduced and published in full and by the client only.

It can be reproduced partially with the written permission of the test laboratory only.

6. Anlagen / Enclosures

	Seiten / Pages
6.1 Verwendungsbereich / <i>Application list</i>	15
6.2 Fotodokumentation / <i>Photo documentation</i>	17
6.3 Maßzeichnungen / <i>Dimensional drawings</i>	30
6.4 Montageanleitung / <i>Assembly instruction</i>	1

München, 18.11.2022



B. Eng. S. Kleemann
Sachverständiger / *Recognized Expert*

Techn.Bericht Nr. / *Techn.*

Report No.: 11-00086-CM-GBM-30

Hersteller / *Manufacturer:* Fechter-Drive Motorsport GmbH

Art / *Kind /* Windschild / *Windshield*

Typ / *Type* 100

Anlage / *Enclosure* 6.1

Verwendungsbereich / *Application list*

Seite *Page* 1/15

Hersteller / <i>manufacturer</i>	Modell / <i>model</i>	Typ / <i>type</i>	ABE / EG	Jahr / <i>year</i>	Standard / <i>standard</i> Höhe/Breite <i>height / width</i> [mm]	Ausführung / <i>version</i>	Tour / <i>touring</i> Höhe/Breite <i>height / width</i> [mm]	Ausführung / <i>version</i>	Sport / <i>sports</i> Höhe/Breite <i>height / width</i> [mm]	Ausführung / <i>version</i>
Aprilia	RSV 1000 R	ME	H827	98-00	340/400	65344001	370/400	65331010	-	-
	RSV 1000SP	ME	H827	98-00	340/400	65344001	370/400	65331010	-	-
	RSV 1000 R	RP	e11*0027*	01-	340/350	65344002	370/340	65331025	-	-
	RSV 1000 SP	RP	e11*0027*	01-	340/350	65344002	370/340	65331025	-	-
	ETV 1000 Caponord	PS	e11*0031*	00-	-		410/390	65331021	-	-
Benelli	TRK 502/ X	P16	e13*168/2013*00123*	17-	435/410	65344003	560/410	65332151	-	-
BMW	CE 04	MCEV	e1*168/2013*00279*	22-	-	-	-	-	350/340	65347142
		MCEVr	e1*168/2013*00280*							
	G 310 GS	5G31	e1*168/2013*00052*	17-	-	-	340/315	65339062	-	-
	G 310 GS	MG31	e1*168/2013*00216*	20-	-	-	340/315	65339062	-	-
	C 650 Sport	C65	e1*0552*	12-15	-	-	700/460	65338057	-	-
	C 650 Sport	3C65	e1*168/2013*00004*	16-	-	-	700/460	65338057	-	-
	C 650 Sport	3C65	e1*168/2013*00005*	16-	-	-	700/460	65338057	-	-
	C 650 GT	C65	e1*0552*	12-15	-	-	730/460	65338058	-	-
	C 650 GT	3C65	e1*168/2013*00004*	16-	-	-	730/460	65338058	-	-
	C 650 GT	3C65	e1*168/2013*00005*	16-	-	-	730/460	65338058	-	-
	F 650	BMW169	G532	93-	-	-	470/340	65339001	-	-
	F 650 GS	R13	e1*0061*	00-	-	-	440/400	65339029	-	-
	F 650 CS Scarver	K14	e1*0130*	01-05	-	-	550/360	65331068	-	-
	F 650 GS	E8GS	e1*0352*	08-	-	-	410/400	65331158	-	-
	F 700 GS	E8GS	e1*0352*03	12-	230/340	65344004	480/420	65339040/41	-	-
	F 750 GS	4G85	e1*168/2013*00058*	19-20	-	-	460/420	65339066	-	-
	F 750 GS	4G85	e1*168/2013*00059*	19-20	-	-	460/420	65339066	-	-
	F 750 GS	MG85	e1*168/2013*00218*	20-	-	-	460/420	65339066	-	-
	F 750 GS	MG85r	e1*168/2013*00217*	20-	-	-	460/420	65339066	-	-
	F 800 GS	E8GS	e1*0352*	08-	-	-	450/410	65339040/41	-	-
F 850 GS	4G85	e1*168/2013*00058*	19-20	-	-	460/420	65339043	-	-	
F 850 GS	4G85	e1*168/2013*00059*	19-20	-	-	460/420	65339043	-	-	
F 850 GS Adventure	4G85	e1*168/2013*00058*	19-20	-	-	460/420	65339043	-	-	

§22 30227*30

Techn.Bericht Nr. / *Techn.*

Report No.:

11-00086-CM-GBM-30

Hersteller / *Manufacturer:*

Fechter-Drive Motorsport GmbH

Art / *Kind /*

Windschild / *Windshield*

Typ / *Type*

100

Anlage / *Enclosure* 6.1

Verwendungsbereich / *Application list*

Seite *Page* 2/15

Hersteller / <i>manufacturer</i>	Modell / <i>model</i>	Typ / <i>type</i>	ABE / EG	Jahr / <i>year</i>	Standard / <i>standard</i> Höhe/Breite <i>height / width</i> [mm]	Ausführung / <i>version</i>	Tour / <i>touring</i> Höhe/Breite <i>height / width</i> [mm]	Ausführung / <i>version</i>	Sport / <i>sports</i> Höhe/Breite <i>height / width</i> [mm]	Ausführung / <i>version</i>	
BMW	F 850 GS Adventure	4G85	e1*168/2013*00059*	19-20	-	-	460/420	65339043	-	-	
	F 850 GS	MG85	e1*168/2013*00218*	20-	-	-	460/420	65339043	-	-	
	F 850 GS	MG85r	e1*168/2013*00217*	20-	-	-	460/420	65339043	-	-	
	F 850 GS Adventure	MG85	e1*168/2013*00218*	20-	-	-	460/420	65339043	-	-	
	F 850 GS Adventure	MG85r	e1*168/2013*00217*	20-	-	-	460/420	65339043	-	-	
	F700 GS / F800 GS	4G80	e1*168/2013*00019*	16-	230/340	65344005	480/420	65339040/41	-	-	
	F700 GS / F800 GS	4G80	e1*168/2013*00021*	16-	230/340	65344005	480/420	65339040/41	-	-	
	F700 GS / F800 GS	4G80r	e1*168/2013*00020*	16-	230/340	65344005	480/420	65339040/41	-	-	
	F700 GS / F800 GS	4G80r	e1*168/2013*00022*	16-	230/340	65344005	480/420	65339040/41	-	-	
	F 900 XR	4R90	4R90	e1*168/2013*00167*	19-	-	-	460/420	65332157	-	-
			4R90r	e1*168/2013*00168*		-	-			-	-
	F 800 R	E8ST	e1*0283*	08-	-	-	320/320	65339012	-	-	
	F 800 GT	E8ST	e1*0283*06	12-	460/450	65344006	665/450	65339002	-	-	
	F 800 GT	4R80	e1*168/2013*00029*	17-	460/450	65344006	665/450	65339002	-	-	
	F 800 GT	4R80	e1*168/2013*00030*	17-	460/450	65344006	665/450	65339002	-	-	
	K75 S	BMW75	D796	85-96	-	-	500/360	65331001	-	-	
	R 80 GS, R 100 GS	BMW247E	B791/1/2	80-96	-	-	390/320	65339003	-	-	
	K100 / LT / RT, K1100 LT	BMW100	D100/1/2	83-99	-	-	660/500	65331002	-	-	
	R 1100 RS	BMW259	G239	92-01	-	-	390/320	65331004	-	-	
	R 850 GS	BMW259	G239	94-99	-	-	410/390	65339005	-	-	
	S 1000 RR	K10	e1*0421*	09-14	470/350	65344007	490/350	65338078	-	-	
	S 1000 RR	K10	e1*0421*	15-17	-	-	400/440	65338079	-	-	
S 1000 XR	K10	e1*0421*	15-17	-	-	450/400	65339042	-	-		
S 1000 XR	2X10	e1*168/2013*00014*	17-18	-	-	450/400	65339042	-	-		
S 1000 XR	2X10r	e1*168/2013*00015*	17-18	-	-	450/400	65339042	-	-		
S 1000 XR	2X99	e1*168/2013*00162*	19-	-	-	480/420	65339067	-	-		
S 1000 XR	2X99r	e1*168/2013*00163*	19-	-	-	480/420	65339067	-	-		

Techn.Bericht Nr. / *Techn.*

Report No.:

11-00086-CM-GBM-30

Hersteller / *Manufacturer:*

Fechter-Drive Motorsport GmbH

Art / *Kind /*

Windschild / *Windshield*

Typ / *Type*

100

Anlage / *Enclosure* 6.1
Verwendungsbereich / *Application list*

Seite *Page* 3/15

Hersteller / <i>manufacturer</i>	Modell / <i>model</i>	Typ / <i>type</i>	ABE / EG	Jahr / <i>year</i>	Standard / <i>standard</i> Höhe/Breite <i>height / width</i> [mm]	Ausführung / <i>version</i>	Tour / <i>touring</i> Höhe/Breite <i>height / width</i> [mm]	Ausführung / <i>version</i>	Sport / <i>sports</i> Höhe/Breite <i>height / width</i> [mm]	Ausführung / <i>version</i>
BMW	S 1000 XR	2X99	e1*168/2013*00162*	19-	-	-	365/340	65339067	-	-
	S 1000 XR	2X99r	e1*168/2013*00163*	19-	-	-	365/340	65339067	-	-
	R 1100 GS	BMW259	G239	94-01	-	-	410/390	65339005	-	-
	R 1150 GS	R21	e1*0041*	99-05	-	-	500/380	65339028	-	-
	R 1100 S	R2S	e1*0102*	01-03	329/360	65344009	350/360	65331064	-	-
	R 1200 ST	R1ST	e1*0230*	05-	-	-	550/510	65339010	-	-
	R 1200 RT	R12T	e1*0228*	05-	-	-	670/590	65339038	-	-
	R 1200 RS	R12WR	e1*0650*	15-	-	-	440/475	65332145	-	-
	R 1200 RS	1R12	e1*168/2013*00008*	16-	-	-	440/475	65332145	-	-
	R 1250 RS	1R13	e1*168/2013*00094*	19-	-	-	440/475	65332145	-	-
	R 1250 RS	1R13ind	e1*168/2013*00171*	19-	-	-	440/475	65332145	-	-
	R 1200 GS	R12	e1*0199*	03-13	-	-	580/430	65339037	-	-
	R 1200 GS LC	R12W	e1*0584*	13-	380/390	65344008	460/390	65339039	-	-
	R 1200 GS	1G12	e1*168/2013*00006*	16-	-	-	580/430	65339039	-	-
	R 1250 GS	1G13	e1*168/2013*00071*	19-	-	-	580/430	65339044	-	-
	R 1250 GS	1G13ind	e1*168/2013*00169*	19-	-	-	580/430	65339044	-	-
K 1200 R	K12R	e1*0234*	05-	-	-	450/380	65331054	-	-	
K 1300 R	K12S	e1*0217*	08-	-	-	410/400	65331045	-	-	
Ducati	750 SS	ZDM750SC	EBE	91-	370/400	65344010	420/400	65331030	-	-
	900 SS / SL	ZDM906SC2	EBE	91-	370/400	65344010	420/400	65331030	-	-
	851	ZDM851S3	EBE	91-	380/410	65344011	410/410	65331031	-	-
	888 SP2/3/4/5	ZDM888S	EBE	91-	370/410	65344012	420/410	65331032	-	-
	748 SP, SPS, Strada	748	H199	94-02	310/345	65344013	330/345	65331035	-	-
	748 SP, SPS, Strada	H3	e1*0037*	99-02	310/345	65344013	330/345	65331035	-	-
	916 Strada, Bipo- sto, SPS	916	G846	94-98	310/345	65344013	330/345	65331035	-	-
	916 SP, Senna	916	G846	94-98	310/345	65344013	330/345	65331035	-	-
	996 R/S	H1	e1*0096*	01-03	310/345	65344013	330/345	65331035	-	-
	996 /SPS	H2	e1*0012*	99-04	310/345	65344013	330/345	65331035	-	-

Techn.Bericht Nr. / *Techn.*

Report No.: 11-00086-CM-GBM-30

Hersteller / *Manufacturer:* Fechter-Drive Motorsport GmbH

Art / *Kind /* Windschild / *Windshield*

Typ / *Type* 100

Anlage / *Enclosure* 6.1
Verwendungsbereich / *Application list*

Seite *Page* 4/15

Hersteller / <i>manufacturer</i>	Modell / <i>model</i>	Typ / <i>type</i>	ABE / EG	Jahr / <i>year</i>	Standard / <i>standard</i> Höhe/Breite <i>height / width</i> [mm]	Ausführung / <i>version</i>	Tour / <i>touring</i> Höhe/Breite <i>height / width</i> [mm]	Ausführung / <i>version</i>	Sport / <i>sports</i> Höhe/Breite <i>height / width</i> [mm]	Ausführung / <i>version</i>	
Ducati	998	H2	e1*0012*	02-	310/345	65344013	330/345	65331035	-	-	
Honda	PCX 125	JF81	e4*168/2013*00083	18-	-	-	-	-	440/300	65347034	
	PCX 125	JF83	e4*168/2013*00084	18-	-	-	-	-	440/300	65347034	
	CBR 125 RR	JC34	e13*0004*	04-	250/280	65344014	270/280	65345013	-	-	
	CBR 125 RR	JC39	e13*0185*	07-	250/280	65344015	270/280	65345017	-	-	
	CBR 125 R	JC50	e9*0445*	11-	345/293	65344016	365/293	65331059	-	-	
	CBR 250 R	MC41	e13*0457*	11-	345/293	65344016	365/293	65331059	-	-	
	CBR 300 R	NC51	e13*0673*	13-	-	-	340/330	65331060	-	-	
	CB 500 X	PC46	PC59	e13*0622*	13-	300/250	65344017	455/300	65332130	-	-
				e13*168/2013*00093*	17-	430/340	65344018	450/340	65332148	-	-
				300/250	65344019	455/300	65332017	-	-		
	PC64	e13*168/2013*00523*	19-	-	-	450/340	65332148	-	-		
	CBR 500 R	PC44	e13*0602*	13-	290/300	65344020	300/300	65332019	-	-	
	CBF 600	PC38	e3*0231*	04-	370/400	65344021	410/400	65332117	-	-	
	CBF 600	PC43	e3*0490*	08-	370/400	65344021	410/400	65332117	-	-	
	CBR 600 F	PC19	E515	-89	240/280	65344022	320/280	65331080	-	-	
	CBR 600 F	PC23	E978	-90	240/280	65344023	320/280	65331086	-	-	
	CBR 600 F	PC25	F648	91-94	280/380	65344024	300/380	65331089	-	-	
	CBR 600 F	PC31	H002	95-	360/300	65344025	400/300	65331091	-	-	
	CBR 600 F	PC31	H002	95-98	315/375	65344025	355/375	65331091	-	-	
	CBR 600 F	PC35	K294	99-00	325/420	65344026	370/420	65345000	-	-	
	CBR 600 F	PC35	e4*0101*	01-	390/430	65344027	420/430	65331093	-	-	
	CBR 600 F Sport	PC35	e4*0101*	01-	390/430	65344028	420/430	65331093	-	-	
	CBR 600 RR	PC37	e4*0190*	03-	315/310	65344029	350/310	65345011	-	-	
CBR 600 RR	PC40	e4*1247*	07-	350/280	65344030	370/280	65345016	-	-		
CBR 600 F	PC41	e3*0454*	11-	344/345	65344031	365/345	65331074	-	-		
XL 600 V Transalp	PD06	E512	95-	-	-	550/380	65331056	-	-		
NC 700 D Integra	RC62	e4*2788*	12-14	-	-	700/640	65332011	-	-		
NC 750 D Integra	RC71	e4*3034*	14-15	-	-	700/640	65332011	-	-		

Techn.Bericht Nr. / *Techn.*

Report No.: 11-00086-CM-GBM-30

Hersteller / *Manufacturer:* Fechter-Drive Motorsport GmbH

Art / *Kind /* Windschild / *Windshield*

Typ / *Type* 100

Anlage / *Enclosure* 6.1
Verwendungsbereich / *Application list*

Seite *Page* 5/15

Hersteller / <i>manufacturer</i>	Modell / <i>model</i>	Typ / <i>type</i>	ABE / EG	Jahr / <i>year</i>	Standard / <i>standard</i> Höhe/Breite <i>height / width</i> [mm]	Ausführung / <i>version</i>	Tour / <i>touring</i> Höhe/Breite <i>height / width</i> [mm]	Ausführung / <i>version</i>	Sport / <i>sports</i> Höhe/Breite <i>height / width</i> [mm]	Ausführung / <i>version</i>
Honda	NC 750 D Integra	RC89	e4*168/2013*00010*	16-	-	-	700/640	65332011	485x485	65347134
	NC 700 X	RC63	e4*2789*	12-14	-	-	455/300	65332126	-	-
	NC 750 X	RC72	e4*3022*	14-15	-	-	455/300	65332126	-	-
	NC 750 X	RC90	e4*168/2013*00007*	16-	370/300	65332142	480/300	65332141	-	-
	NC 700 S	RC61	e4*2824*	12-14	-	-	460/300	65332125	-	-
	NC 750 S	RC70	e4*3021*	14-15	-	-	460/300	65332125	-	-
	NC 750 S	RC88	e4*168/2013*00011*	16-	-	-	330/230	65332098	-	-
	NC 750 X	RH09	e6*168/2013*00066*	21-	-	-	480/340	65332164	-	-
	NC 750 X	RH09	e6*168/2013*00067*	21-	-	-	480/340	65332164	-	-
	Forza 125	JF69	e4*168/2013*00044	19-	-	-	-	-	390/425	65347008
	Forza 125	JK02	e4*168/2013*00145*	21-	-	-	-	-	410/395	65347143
	Forza 300	NF08	e4*168/2013*00087	18-	-	-	-	-	390/425	65347029
	Forza 350	NF10	e4*168/2013*00146*	21-	-	-	-	-	410/395	65347144
	Forza 750	RH11	e6*168/2013*00064*	20-	-	-	630/560	65332166	480/480	65347145
	Forza 750	RH11	e6*168/2013*00065*	20-	-	-	630/560	65332166	480/480	65347145
	XRV 750 Africa Twin	RD04	F371	90-92	-	-	500/320	65331003	-	-
	XRV 750 Africa Twin	RD07	G317	93-	340/380	65344032	460/380	65331005	-	-
	CFR 1000 Africa Twin	SD07	e4*3185*	15-	380/370	65332144	490/370	65332143	-	-
	CRF1100L Africa Twin	SD08	e4*168/2013*00118*	19-	-	-	500/375	65332155	-	-
	CRF1100L Africa Twin Adv. Sports	SD09	e4*168/2013*00115*	19-	-	-	500/375	65332156	-	-
VFR 750 F	RC36	F372	90-93	430/380	65344033	470/380	65331009	-	-	
VFR 800	RC46	K011	98-01	355/420	65344034	410/420	65331012	-	-	
VFR 800	RC46	e4*0132*	02-	430/440	65344035	470/440	65332115	-	-	
VFR 800 F	RC79	e4*3054*	14-	-	-	450/410	65331015	-	-	
VFR 800 X Crossrunner	RC60	e4*2673*	11-14	-	-	420/455	65332123	-	-	

Techn.Bericht Nr. / *Techn.*

Report No.:

11-00086-CM-GBM-30

Hersteller / *Manufacturer:*

Fechter-Drive Motorsport GmbH

Art / *Kind /*

Windschild / *Windshield*

Typ / *Type*

100

Anlage / *Enclosure* 6.1
Verwendungsbereich / *Application list*

Seite *Page* 6/15

Hersteller / <i>manufacturer</i>	Modell / <i>model</i>	Typ / <i>type</i>	ABE / EG	Jahr / <i>year</i>	Standard / <i>standard</i> Höhe/Breite <i>height / width</i> [mm]	Ausführung / <i>version</i>	Tour / <i>touring</i> Höhe/Breite <i>height / width</i> [mm]	Ausführung / <i>version</i>	Sport / <i>sports</i> Höhe/Breite <i>height / width</i> [mm]	Ausführung / <i>version</i>
Honda	VFR 800 X Crossrunner	RC80	e4*3110*	15-	-	-	450/390	65332135	-	-
	VFR 800 X	RC94	e4*168/2013*00041*	17-	-	-	450/390	65332029	-	-
	VFR 1200 Crosstourer	SC76	e4*168/2013*00012*	16-	-	-	480/320	65332146	-	-
	CBR 900 RR	SC28	G034	92-93	300/330	65344036	350/330	65331013	-	-
	CBR 900 RR	SC28	G034	94-	340/340	65344037	400/340	65331014	-	-
	CBR 900 RR	SC33	H294	96-	340/340	65344038	400/340	65331016	-	-
	CBR 900 RR	SC33	H294	98-	300/380	65341122	320/380	65345001	-	-
	CBR 900 RR	SC44	e13*0019*	00-	320/410	65331141	365/410	65331099	-	-
	CBR 900 RR	SC50	e13*0052*	02-	300/330	65331142	330/330	65345007	-	-
	CBR 1000 RR	SC57	e4*0269*	04-	300/330	65344039	335/335	65345012	-	-
	CBR 1000 RR	SC59	e4*1726*	08-	275/280	65344040	295/280	65345018	-	-
	CBR 1000 F	SC24	F143	89-92	350/380	65344041	430/380	65331020	-	-
	CBR 1000 F	SC24	F143	93-94	370/410	65344042	410/410	65331022	-	-
	CBF 1000	SC58	e3*0373*	06-	420/450	65344043	440/450	65332118	-	-
	CBF 1000 F	SC64	e4*2395*	10-	415/400	65344044	465/400	65332122	-	-
	VTR 1000 F	SC36	e13*0044*	96-	350/355	65331091	380/355	65345003	-	-
	Varadero 1000	SD01	e4*0009*	98-02	-	-	585/555	65332133	-	-
	XL 1000 V	SD02	e9*0059*	01-03	-	-	590/310	65331041	-	-
	CRF 1000 L	SD06	e4*168/2013*00033*	16-	380/370	65344045	490/370	65332025	-	-
	VTR 1000 SP1	SC45	e4*0061*	99-01	315/310	65341124	360/310	65345004	-	-
	VTR 1000 SP2	SC45	e4*0061*	02-	315/310	65341124	360/310	65345004	-	-
	CBR 1100 XX	SC35	H541	96-	400/425	65344046	430/425	65332121	-	-
	CBR 1100 XX	SC35	e13*0043*	96-	400/425	65344046	430/425	65332121	-	-
	VFR 1200 F	SC63	e4*2383*	10-	420/400	65344047	-	-	-	-
	Crosstourer 1200	SC70	e4*2701*	12-	-	-	420/390	65332127	-	-
	X-ADV	RC95	e4*168/2013*00060*	17-	430/330	65344048	450/335	65339063	-	-
X-ADV 750	RH10	e6*168/2013*00058*	20-	-	-	470/360	65332163	-	-	
X-ADV 750	RH10	e6*168/2013*00057*	20-	-	-	470/360	65332163	-	-	
NT 1100/ DCT	SC84	e4*168/2013*00155*	21-	470/440	65332171	600/465	65332170	-	-	

Techn.Bericht Nr. / *Techn.*

Report No.: 11-00086-CM-GBM-30

Hersteller / *Manufacturer:* Fechter-Drive Motorsport GmbH

Art / *Kind /* Windschild / *Windshield*

Typ / *Type* 100

Anlage / *Enclosure* 6.1
Verwendungsbereich / *Application list*

Seite *Page* 7/15

Hersteller / <i>manufacturer</i>	Modell / <i>model</i>	Typ / <i>type</i>	ABE / EG	Jahr / <i>year</i>	Standard / <i>standard</i> Höhe/Breite <i>height / width</i> [mm]	Ausführung / <i>version</i>	Tour / <i>touring</i> Höhe/Breite <i>height / width</i> [mm]	Ausführung / <i>version</i>	Sport / <i>sports</i> Höhe/Breite <i>height / width</i> [mm]	Ausführung / <i>version</i>
Kawasaki	Ninja 300	EX300A	e1*0572*	12-	350/350	65344049	360/350	65332040	-	-
	ZX 400	ZX400L	F669	93	340/360	65344050	380/360	65331047	-	-
	GPZ 500 S	EX500A	E444	87-	410/300	65344051	430/300	65331048	-	-
	GPZ 500 S	EX500A	E444	87-	360/360	65344052	460/360	65331049	-	-
	GPZ 600 R	ZX600A	D753	85-92	330/320	65344053	430/320	65331050	-	-
	GPX 600 R	ZX600A	D753	85-92	330/330	65344054	430/320	65331051	-	-
	ZZR 600	ZX600D	F382	93-	380/330	65344055	410/330	65331052	-	-
	ZZR 600	ZX600E	G418	95-	370/370	65344056	460/370	65331053	-	-
	ZX-6R	ZX600F	G937	94-97	410/360	65341355	460/360	65331055	-	-
	ZX-6R	ZX600G/H	H967	98-	410/360	65341355	460/360	65331057	-	-
	ZX-6R	ZX600J	e4*0042*	02-	385/320	65341212	440/320	65345048	-	-
	ZX-6R	ZX636A	e1*0141*	02-03	385/320	65341212	440/320	65345048	-	-
	ZX-6R	ZX636B	e4*0180*	03-04	385/320	65341212	440/320	65345048	-	-
	ZX-6R	ZX636C	e1*0229*	05-06	380/320	65344057	400/320	65345049	-	-
	ZX-6R	ZX600P	e4*1274*	07-08	380/320	65344058	400/320	65345049	-	-
	ZX-6R	ZX600R	e4*2077*	09-	340/340	65344059	360/340	65331100	-	-
	ZX-6RR	ZX600N	e4*0364*	05-	380/320	65344060	400/320	65331085	-	-
	ZX 6R Ninja 636	ZX636E	e1*0571*	13-	330/340	65344061	340/350	65331154	-	-
	Versys 650	LE650E	e1*0653*	15-	-	-	410/450	65332124	-	-
	Versys 650	LE650E	e4*168/2013*00027*	17-	-	-	410/450	65332124	-	-
	Versys 650	LE650EA2	e4*168/2013*00028*	17-	-	-	410/450	65332124	-	-
	Z 750	ZR750J	e1*0197*	04-	-	-	310/340	65342083	-	-
	Z 750	ZR750L	e1*0309*	07-	-	-	310/340	65342085	-	-
	GPZ 750 R	ZX750G	D608	84-87	360/370	65344062	460/370	65331028	-	-
	ZXR 750	ZX750J	F671	91-92	370/420	65344063	360/420	65331027	-	-
	ZXR 750	ZX750L	G154	93-	340/350	65344064	370/350	65331029	-	-
	ZXR 750	ZX750L	G154	96	380/410	65344065	390/410	65331033	-	-
ZX 7R	ZX750N	H202	95-	360/410	65344066	410/410	65331034	-	-	
GPZ 900 R	ZX900A	D363	94-	360/370	65344067	460/370	65331036	-	-	
ZX 9R	ZX900B	G588	94-97	360/380	65344068	420/380	65331037	-	-	

§22 30227*30

Techn.Bericht Nr. / *Techn.*

Report No.: 11-00086-CM-GBM-30

Hersteller / *Manufacturer:* Fechter-Drive Motorsport GmbH

Art / *Kind /* Windschild / *Windshield*

Typ / *Type* 100

Anlage / *Enclosure* 6.1
Verwendungsbereich / *Application list*

Seite *Page* 8/15

Hersteller / <i>manufacturer</i>	Modell / <i>model</i>	Typ / <i>type</i>	ABE / EG	Jahr / <i>year</i>	Standard / <i>standard</i> Höhe/Breite <i>height / width</i> [mm]	Ausführung / <i>version</i>	Tour / <i>touring</i> Höhe/Breite <i>height / width</i> [mm]	Ausführung / <i>version</i>	Sport / <i>sports</i> Höhe/Breite <i>height / width</i> [mm]	Ausführung / <i>version</i>
Kawasaki	ZX 9R	ZX900C/D	H844	98-99	340/420	65341112	370/420	65331038	-	-
	ZX 9R	ZX900E/F	e1*0054*	00-03	355/360	65331393	410/360	65345044	-	-
	ZX 10R	ZXT00C	e4*0246*	04-05	380/320	65344069	410/320	65345040	-	-
	ZX 10R	ZXT00D	e1*0270*	06-07	380/350	65344070	400/350	65331039	-	-
	ZX 10R	ZXT00E	e1*0350*	08-09	340/340	65344071	360/340	65345056	-	-
	ZX 10R	ZXT00F	e1*0443*	10-10	340/340	65344071	360/340	65345056	-	-
	ZX 10R	ZXT00J	e4*2548*	11-	400/530	65344072	420/530	65331040	-	-
	GPZ 1000 RX	ZXT00A	D994	85-93	410/340	65344073	460/340	65331042	-	-
	ZX 10	ZXT00B	E795	88-92	460/380	65344074	470/380	65331043	-	-
	Z 1000	ZRT00A	e1*0172*	03-06	-	-	430/340	65342082	-	-
	Z 1000	ZRT00B	e4*1275*	07-09	-	-	430/340	65342084	-	-
	Z 1000	ZRT00D	e4*2374*	10-	-	-	365/360	65342086	-	-
	Z 1000 SX	ZXT00G	e1*0486*	11-	433/380	65344075	510/380	65332912	-	-
	Z 1000 SX	ZXT00W	e4*168/2013*00034*	17-	433/380	65344075	510/380	65332912	-	-
	Ninja 1000 SX	ZXT02K	e4*168/2013*00116*	19-	-	-	495/355	65332167	-	-
	GPZ 1100	ZXT10E	G936	94-99	410/400	65344076	440/400	65331044	-	-
	Versys 300	LE300C	e4*168/2013*00049*	17-	-	-	450/355	65339064	-	-
	Versys 1000	LZT00A	e1*0540*	12-14	-	-	410/450	65332124	-	-
	Versys 1000	LZT00B	e1*3111*	15-	-	-	410/450	65332124	-	-
	Versys 1000	LZT00W	e4*168/2013*00029*	17-	-	-	410/450	65339006	-	-
	Versys 1000	LZT00C	e4*168/2013*00086*	17-	-	-	410/450	65339006	-	-
	Ninja H2	ZXT00N	e4*3112*	15-	-	-	385/335	65332004	-	-
	ZZR 1100	ZXT10C	F381	89-92	460/370	65344077	550/370	65331046	-	-
	ZZR 1100	ZXT10D	G203	92-01	460/400	65344078	510/400	65331058	-	-
	ZZR 1200	ZXT20C	e1*0142*	02-	420/430	65344079	460/430	65331061	-	-
	ZZR 1400	ZXT40A	e4*0912*	06-	410/440	65344080	430/440	65331062	-	-
ZX 12 R	ZXT20A	e1*0065*	00-	410/380	65344081	450/380	65331063	-	-	
ZX 12 R	ZXT20A	e1*0065*	02-	410/380	65341116	450/380	65345047	-	-	
ZZR 1400	ZXT40E	e4*2810*	12-	385/355	65344082	-	-	-	-	

§22 30227*30

Techn.Bericht Nr. / *Techn.*

Report No.: 11-00086-CM-GBM-30

Hersteller / *Manufacturer:* Fechter-Drive Motorsport GmbH

Art / *Kind /* Windschild / *Windshield*

Typ / *Type* 100

Anlage / *Enclosure* 6.1

Verwendungsbereich / *Application list*

Seite *Page* 9/15

Hersteller / <i>manufacturer</i>	Modell / <i>model</i>	Typ / <i>type</i>	ABE / EG	Jahr / <i>year</i>	Standard / <i>standard</i> Höhe/Breite <i>height / width</i> [mm]	Ausführung / <i>version</i>	Tour / <i>touring</i> Höhe/Breite <i>height / width</i> [mm]	Ausführung / <i>version</i>	Sport / <i>sports</i> Höhe/Breite <i>height / width</i> [mm]	Ausführung / <i>version</i>
KTM	KTM 390 Adventure	KTM IS Adventure	e1*168/2013*00209*	19-	-	-	400/340	65332160	-	-
	1190 Adventure	KTM Adventure	e1*0596*	13-	380/250	65344083	425/375	65332147	-	-
	1050 Adventure	KTM Adventure	e1*0596*	15-	-	-	425/375	65332147	-	-
	1290 Super Adventure	KTM Adventure	e1*0596*	15-	-	-	450/385	65332015	-	-
	1290 Super Adventure R/S	KTM Adventure	e1*168/2013*00031*	17-20	-	-	480/445	65332154	-	-
	1290 Super Adventure S/R	KTM V2 Adventure	e1*168/2013*00274*	21-	-	-	480/445	65332154	-	-
Kymco	AK 550i	E1-A3	e13*168/2013*00121	17-	-	-	-	-	490/400	65347049
	AK 550i	E1-A2	e13*168/2013*00122	17-	-	-	-	-	490/400	65347049
	DT X360 350i	E7	e13*168/2013*01039	22-	-	-	-	-	370/330	65347147
	DT X360 125i	E8	e13*168/2013*01102	22-	-	-	-	-	370/330	65347147
	NEW DOWNTOWN 125	V2	e4*2136	15-	-	-	-	-	490/355	65347057
	NEW DOWNTOWN 125	V2	e13*168/2013*00005	16-	-	-	-	-	490/355	65347057
	NEW DOWNTOWN 350	V2	e4*2136	15-	-	-	-	-	490/355	65347057
	NEW DOWNTOWN 350	C7	e13*168/2013*00006	16-	-	-	-	-	490/355	65347057
	Xciting S 400i	D6	e13*168/2013*00007	18-	-	-	-	-	450/400	65347064
	X-Town 125	KS25A	e13*168/2013*00014	16-	-	-	-	-	430/390	65347066
	X-Town 125	W1	e13*168/2013*00967	21-	-	-	-	-	430/390	65347066
	X-Town 300	KS60A	e13*168/2013*00013	16-	-	-	-	-	430/390	65347066
X-Town 300	C0	e13*168/2013*00984	21-	-	-	-	-	430/390	65347066	
Moto Guzzi	V85 TT	KW	e1*168/2013*00158*	19-	-	-	480/425	65332153	-	-
		KX	e1*168/2013*00159*	19-	-	-	480/425	65332153	-	-
		KX1	e11*168/2013*00328*	19-	-	-	480/425	65332153	-	-

Techn.Bericht Nr. / *Techn.*

Report No.: 11-00086-CM-GBM-30

Hersteller / *Manufacturer:* Fechter-Drive Motorsport GmbH

Art / *Kind /* Windschild / *Windshield*

Typ / *Type* 100

Anlage / *Enclosure* 6.1

Verwendungsbereich / *Application list*

Seite *Page* 10/15

Hersteller / <i>manufacturer</i>	Modell / <i>model</i>	Typ / <i>type</i>	ABE / EG	Jahr / <i>year</i>	Standard / <i>standard</i> Höhe/Breite <i>height / width</i> [mm]	Ausführung / <i>version</i>	Tour / <i>touring</i> Höhe/Breite <i>height / width</i> [mm]	Ausführung / <i>version</i>	Sport / <i>sports</i> Höhe/Breite <i>height / width</i> [mm]	Ausführung / <i>version</i>
Moto Guzzi	V85 TT	KY	e49*168/2013*00065*	21-	-	-	480/425	65332153	-	-
		MB	e49*168/2013*00066*	21	-	-	480/425	65332153	-	-
Peugeot	Metropolis 400	X1	e2*0056*	13-	-	-	-	-	420/430	65347076
Piaggio	MP3 300 HPE/Sport	TA2	e9*168/2013*11358*	19-	-	-	-	-	590/400	65347085
	MP3 350 HPE Sport	TA1	e9*168/2013*11015*	19-	-	-	-	-	510/485	65347089
	MP3 400 HPE/Sport	TD1	e9*168/2013*11717*	21-	-	-	-	-	510/485	65347089
	MP3 500 HPE Sport /Business	TA1	e9*168/2013*11015	19-	-	-	-	-	510/485	65347089
	MP3 500 HPE Sport	TD1	e9*168/2013*11717*	21-	-	-	-	-	510/485	65347089
	MP3 400 Exclusive	TD1	e9*168/2013*11717*	21-	-	-	-	-	510/470	65347149
Suzuki	AN 400 Burgman	WDU0	e4*e2*0056*00067	17-	-	-	-	-	440/370	65347112
	GSX-R 600	AD	H583	96-00	410/410	65344084	440/410	65331120	-	-
	GSX-R 600	AD	H583	96-00	390/400	65344085	440/400	65331121	-	-
	GSX-R 600	WVBG	e4*0100*	01-	330/545	65344086	360/545	65331122	-	-
	GSX-R 600	WVB2	e4*0253*	04-	330/550	65344087	380/550	65345078	-	-
	GSX-R 600	WVCE	e4*0849*	06-	340/530	65344088	360/530	65345067	-	-
	GSX-R 600	WVCV	e4*1756*	08-	290/310	65344089	310/310	65345064	-	-
	GSX-R 600	C3	e4*2578*	11-	274/295	65344090	295/295	65331123	-	-
	GSF 600	GN77B	H008	95-	315/360	65344091	370/360	65331124	-	-
	GSF 600	WVA8	e4*0060*	00-	355/430	65344092	385/430	65332672	-	-
	GSX 600 F	GN72B	E775	87-98	310/300	65344093	430/300	65331088	-	-
	GSX 600 F	AJ	H928	98-	310/390	65344094	340/390	65331087	-	-
	RF 600 R	GN76A	EBE	93-97	370/400	65344095	500/400	65331082	-	-
	RF 600 R	GN76B	G319	93-96	370/400	65344096	500/400	65331083	-	-
	SV 650 S	AV	K329	99-02	295/350	65344097	350/350	65331084	-	-
	SV 650 S	WVBY	e4*0192*	03-	360/360	65344098	400/360	65331097	-	-
	DL 650 V Strom	C7	e4*2680*	11-	-	-	500/335	65332128	-	-
	DL 650 V-Strom	WC70	e4*168/2013*00035*	17-	-	-	500/335	65332149	-	-
	DL 650 V-Strom	WC71	e4*168/2013*00036*	17-	-	-	500/335	65332149	-	-
	GSX 750 F	GR78A	F025	88-98	370/320	65344099	430/320	65331006	-	-

Techn.Bericht Nr. / *Techn.*

Report No.:

11-00086-CM-GBM-30

Hersteller / *Manufacturer:*

Fechter-Drive Motorsport GmbH

Art / *Kind /*

Windschild / *Windshield*

Typ / *Type*

100

Anlage / *Enclosure* 6.1
Verwendungsbereich / *Application list*

Seite Page 11/15

Hersteller / <i>manufacturer</i>	Modell / <i>model</i>	Typ / <i>type</i>	ABE / EG	Jahr / <i>year</i>	Standard / <i>standard</i> Höhe/Breite <i>height / width</i> [mm]	Ausführung / <i>version</i>	Tour / <i>touring</i> Höhe/Breite <i>height / width</i> [mm]	Ausführung / <i>version</i>	Sport / <i>sports</i> Höhe/Breite <i>height / width</i> [mm]	Ausführung / <i>version</i>
Suzuki	GSX 750 F	GR79B	F195	88-98	370/320	65344100	430/320	65331007	-	-
	GSX 750 F	AK	K222	98	310/390	65344101	340/390	65331008	-	-
	GSX-R 750	GR75A	D788	88-89	310/410	65344102	330/410	65331011	-	-
	GSX-R 750	GR77A	EBE	90-91	290/370	65344103	310/370	65331017	-	-
	GSX-R 750	GR77B	E776	90-91	290/370	65344103	310/370	65331017	-	-
	GSX-R 750	GR7AB/AD/AA	F345	90-	250/410	65344104	260/410	65331018	-	-
	GSX-R 750	GR7BB/BA	F971	92-	290/360	65344105	330/360	65331019	-	-
	GSX-R 750	GR7BB/BA	F971	92-	330/400	65344106	350/400	65331023	-	-
	GSX-R 750	GR7DB/DA	H254	94-	410/410	65344107	460/410	65331024	-	-
	GSX-R 750	WVBD	e4*0068*	00-	330/550	65344108	380/550	65345071	-	-
	GSX-R 750	WFCF	e4*0890*	06-	340/530	65344109	360/530	65331026	-	-
	GSX-R 750	WVB3	e4*0261*	04-	330/550	65344087	380/350	65345078	-	-
	GSX-R 750	WVCW	e4*1852*	08-	290/310	65344089	310/310	65345064	-	-
	GSX-R 750	C4	e4*2587*	11-	274/295	65344110	295/295	65331065	-	-
	DL 1000 V-Strom	WVBS	e4*0142*	02-07	-	-	440/420	65332872	-	-
	DL 1000 V- Strom	WDD0	e4*168/2013*00053*	17-	-	-	500/335	65332150	-	-
	GSX-R 1000	WVBL	e4*0108*	01-	330/540	65344111	360/540	65331066	-	-
	GSX-R 1000	WVBZ	e4*0193*	03-	330/540	65341214	360/540	65345077	-	-
	GSX-R 1000	WVB6	e4*0375*	05-	340/530	65344112	370/530	65345069	-	-
	GSX-R 1000	WVCL	e4*1343*	07-	260/320	65344113	280/320	65345066	-	-
	GSX-R 1000	WVCY	e4*2132*	09-	325/360	65344114	345/360	65345062	-	-
	GSX-R 1100	GU74C	F725	89-90	310/450	65344115	330/450	65331067	-	-
	GSX-R 1100	GV73A/B/C	F024	91-92	270/420	65344116	300/420	65331069	-	-
	GSX-R 1100	GV73A/B/C	F024	93-	270/410	65344117	290/410	65331070	-	-
	GSX-R 1100	GU75B/C	G253	96-	330/370	65344118	350/370	65331071	-	-
RF 900 R	GT73A /B	G616	94-97	370/400	65344119	500/400	65331072	-	-	
TL 1000 S	AG	H632	97-03	390/360	65344120	420/360	65331073	-	-	
TL 1000 R	AM	H977	98-	390/310	65344121	410/310	65331075	-	-	
SV 1000 S	WVBX	e4*0191*	03-	360/360	65344122	400/360	65331076	-	-	

S22 30227*30

Techn.Bericht Nr. / *Techn.*

Report No.: 11-00086-CM-GBM-30

Hersteller / *Manufacturer:* Fechter-Drive Motorsport GmbH

Art / *Kind /* Windschild / *Windshield*

Typ / *Type* 100

Anlage / *Enclosure* 6.1

Verwendungsbereich / *Application list*

Seite *Page* 12/15

Hersteller / <i>manufacturer</i>	Modell / <i>model</i>	Typ / <i>type</i>	ABE / EG	Jahr / <i>year</i>	Standard / <i>standard</i> Höhe/Breite <i>height / width</i> [mm]	Ausführung / <i>version</i>	Tour / <i>touring</i> Höhe/Breite <i>height / width</i> [mm]	Ausführung / <i>version</i>	Sport / <i>sports</i> Höhe/Breite <i>height / width</i> [mm]	Ausführung / <i>version</i>
Suzuki	GSX-S 1000 F	DG	e4*3135*	15-	-	-	560/360	65332140	-	-
	GSX-S 1000 F	WDG0	e4*168/2013*00051*	17-	-	-	560/360	65332140	-	-
	GSX-S 1000 GT	WEK0	e6*168/2013*00087*	22-	-	-	495/390	65332174	-	-
	GSF 1200	GV75A	H344	96-00	315/360	65344123	370/360	65331077	-	-
	GSF 1200	WVA9	e4*0086*	01-	355/430	65344124	385/430	65331078	-	-
	GSX 1300 R	WVA1	e4*0012*	99-05	385/440	65344125	420/440	65331079	-	-
	GSX 1300 R	WVA1	e4*0852*	06-07	385/440	65344126	420/440	65331081	-	-
GSX 1300 R	WVCK	e4*1618*	08-	370/420	65344127	390/420	65345063	-	-	
SYM	Cruisym 125	LV_A1	e13*168/2013*00879*	22-	-	-	-	-	550/430	65347150
	Cruisym 300	LN-A2	e13*168/2013*00035*	18-	-	-	-	-	500/380	65347114
	Cruisym 300	LV_AS	e13*168/2013*00880*	22-	-	-	-	-	550/430	65347150
	Joymax Z 125	LW_A1	e13*168/2013*00557*	19-	-	-	-	-	400/380	65347116
	Joymax Z + 125	LW_A1	e13*168/2013*00557*	22-	-	-	-	-	550/430	65347151
	Joymax Z 300	LN-A2	e13*168/2013*00035*	19-	-	-	-	-	400/380	65347116
Maxsym 500 LT	TL	e13*168/2013*00609*	20-	-	-	-	-	470/420	65347118	
Triumph	Daytona 675 / R	H67	e11*1592*	13-	335/330	65344128	340/330	65332028	-	-
	Trophy	V13VH	e11*1511*	12-	570/690	65344129	650/690	65332031	-	-
	Tiger 800/XC	A08	e11*1048*	11-15	-	-	460/310	65332129	-	-
	Tiger 800 XCX/XC/XCA	A082	e11*1831*	15-	-	-	460/310	65332129	-	-
	Tiger 800 XCX/XC/XCA	A082	e11*1831*	15-	-	-	460/310	65332129	-	-
	Tiger 800	C201	e11*168/2013*00215*	16-	-	-	460/310	65332129	-	-
	Tiger Explorer 1200	V13VG	e11*1228*	12-15	-	-	495/310	65332052	-	-
Tiger Explorer X 1200	V201	e11*168/2013*00208*	16-	-	-	495/310	65332052	-	-	
Yamaha	YZF R 125	RE06	e13*0248*	08-13	360/270	65344130	380/270	65345094	-	-
	YZF R 125	RE11	e13*0697*	14-	-	-	350/260	65332041	-	-
	YZF R 125	RG10	e13*0742*	15-	-	-	335/310	65332042	-	-
	YZF R3	RH07	e13*0741*	15-	-	-	335/310	65332042	-	-
	T-Max 560	SJ18	e13*168/2013*00660	2020-	-	-	-	-	360/450	65347122

Techn.Bericht Nr. / *Techn.*

Report No.: 11-00086-CM-GBM-30

Hersteller / *Manufacturer:* Fechter-Drive Motorsport GmbH

Art / *Kind /* Windschild / *Windshield*

Typ / *Type* 100

Anlage / *Enclosure* 6.1
Verwendungsbereich / *Application list*

Seite *Page* 13/15

Hersteller / <i>manufacturer</i>	Modell / <i>model</i>	Typ / <i>type</i>	ABE / EG	Jahr / <i>year</i>	Standard / <i>standard</i> Höhe/Breite <i>height / width</i> [mm]	Ausführung / <i>version</i>	Tour / <i>touring</i> Höhe/Breite <i>height / width</i> [mm]	Ausführung / <i>version</i>	Sport / <i>sports</i> Höhe/Breite <i>height / width</i> [mm]	Ausführung / <i>version</i>	
Yamaha	T-Max 560	SJ18	e13*168/2013*00660	2022-	-	-	-	-	405/450	65347152	
	X-Max 125	SEC3	e13*168/2013*00050*	2017-	-	-	-	-	410/395	65347126	
	X-Max 125	SEE6	e13*168/2013*00284	2018-	-	-	-	-	410/395	65347126	
	X-Max 125	SEH3	e13*168/2013*00985	2021-	-	-	-	-	410/395	65347126	
	X-Max 300	SH08	e13*168/2013*00043	2017-	-	-	-	-	410/395	65347128	
	X-Max 300	SH13	e13*168/2013*00287*	2018-	-	-	-	-	410/395	65347128	
	X-Max 300	SH14	e13*168/2013*00901*	2021-	-	-	-	-	410/395	65347128	
	X-Max 400	SH11	e13*168*2013*00079	2017-	-	-	-	-	410/395	65347132	
	X-Max 400	SH12	e13*168*2013*00241	2018-	-	-	-	-	410/395	65347132	
	Tricity 125	SE78	e13*2002/24*0699	2014-	-	-	-	-	350/380	65347138	
	Tricity 125	SEC2	e13*168/2013*00049*	2017-	-	-	-	-	350/380	65347138	
	Tricity 300	SH16	e13*168/2013*00673*	2020-	-	-	-	-	410/395	65347140	
	Tricity 300	SH20	e13*168/2013*00907*	2021-	-	-	-	-	410/395	65347140	
	FZR 600	3HE	F103		88-	310/400	65344131	330/400	65331092	-	-
	FZR 600	3RH	F153		88-	310/400	65344131	330/400	65331092	-	-
	FZR 600	3RG	F152		89-	310/420	65344132	330/420	65331094	-	-
	FZR 600	4JH	G653		98-	310/440	65344133	340/440	65331095	-	-
	FZS 600	RJ02	H988		98-03	310/400	65344134	330/400	65331096	-	-
	FZS 600	RJ02	H988		98-03	270/340	65344135	320/340	65331098	-	-
	FZS 600	RJ02	H988		02-	320/300	65344136	350/300	65345089	-	-
	XJ 600 S Diversio	4BR	F904		91-97	310/440	65344137	360/410	65332381	-	-
	XJ 600 S Diversio	4BRA	F945		92-97	310/440	65344137	360/410	65332381	-	-
	XJ 600 S Diversio	4BRA	F945		92-97	-	-	420/360	65332001	-	-
XJ 600 S Diversio	4BRB	F944		92-97	310/440	65344137	360/410	65332381	-	-	
XJ 600 S Diversio	4BRB	F944		92-97	-	-	420/360	65332001	-	-	
YZF 600 R	4WD	H653		97-00	380/340	65344139	450/340	65331090	-	-	

§22 30227*30

Techn.Bericht Nr. / *Techn.*

Report No.: 11-00086-CM-GBM-30

Hersteller / *Manufacturer:* Fechter-Drive Motorsport GmbH

Art / *Kind /* Windschild / *Windshield*

Typ / *Type* 100

Anlage / *Enclosure* 6.1
Verwendungsbereich / *Application list*

Seite *Page* 14/15

Hersteller / <i>manufacturer</i>	Modell / <i>model</i>	Typ / <i>type</i>	ABE / EG	Jahr / <i>year</i>	Standard / <i>standard</i> Höhe/Breite <i>height / width</i> [mm]	Ausführung / <i>version</i>	Tour / <i>touring</i> Höhe/Breite <i>height / width</i> [mm]	Ausführung / <i>version</i>	Sport / <i>sports</i> Höhe/Breite <i>height / width</i> [mm]	Ausführung / <i>version</i>
Yamaha	YZF 600 R	4TV	H441	96-07	380/340	65344139	450/340	65331090	-	-
	YZF R6	RJ03	K265	99-00	260/450	65341504	290/450	65331101	-	-
	YZF R6	RJ03	K265	01-02	280/370	65344140	340/370	65331102	-	-
	YZF R6	RJ05	e13*0060*	03-	400/370	65344141	430/370	65345082	-	-
	YZF R6	RJ09	e13*0073*	04-	400/370	65344141	430/370	65345082	-	-
	YZF R6	RJ11	e13*0038*	06-	420/350	65344142	450/350	65345091	-	-
	YZF R6	RJ15	e13*0233*	08-	310/340	65344143	330/340	65345095	-	-
	YZF 750 R	4HN / 4HS	G346	93-99	330/340	65344144	380/440	65331103	-	-
	Tenere 700	DM07	e13*168/2013*00648*	19-20	-	65344145	325/280	65332152	-	-
	Tenere 700	DM08	e13*168/2013*00649*	19-20	-	65344145	325/280	65332152	-	-
	Tenere 700	DM11	e13*168/2013*00986*	21-	-	65344145	325/280	65332152	-	-
	Tenere 700	DM11	e13*168/2013*00986*	21-	-	65344145	325/280	65332152	-	-
	TDM 850	3VD	F699	91-	-	65344146	340/300	65332831	-	-
	TDM 850	4CM	F843	91-97	-	65344146	340/300	65332831	-	-
	TDM 850	4TX	H442	96-	-	65344147	420/360	65332891	-	-
	TRX 850	4UN	H283	96-	400/370	65344148	450/370	65332892	-	-
	TDM 900	RN08	e13*0053*	02-	310/310	65344149	340/310	65332852	-	-
	XJ 900 S Diversion	4KM	G844	94-	410/360	65344150	510/360	65332881	-	-
	MT-07 Tracer	RM14	e13*168/2013*00024*	16-	365/300	65339061	490/385	65339060	-	-
	MT-07 Tracer	RM15	e13*168/2013*00025*	16-	365/300	65339061	490/385	65339060	-	-
	Tracer 700 (MTT690-A)	RM30	e13*168/2013*00782*	20-	-	65344151	490/385	65332158	-	-
	Tracer 700 (MTT690-U)	RM31	e13*168/2013*00783*	20-	-	65344151	490/385	65332158	-	-
	MT-09 Tracer	RN29	e13*0643*	15-16	350/410	65332900	500/410	65332899	-	-
	MT-09 Tracer	RN43	e13*168/2013*00002* 02	17-	350/410	65332900	500/410	65332899	-	-
Tracer 900 / GT	RN57	e13*168/2013*00286*	18-	350/410	65331392	500/410	65331394	-	-	
Tracer 9 / GT	RN70	e13*168/2013*00954*	21-	360/360	65332169	500/415	65332168	-	-	
MT-10 (SP)	RN45	e13*168/2013*00008*	16-	380/360	65344152	470/360	65332903	-	-	
FZR 1000	2LA	E558	87-89	360/430	65344153	360/430	65331104	-	-	

Techn.Bericht Nr. / *Techn.*

Report No.: 11-00086-CM-GBM-30

Hersteller / *Manufacturer:* Fechter-Drive Motorsport GmbH

Art / *Kind /* Windschild / *Windshield*

Typ / *Type* 100

Anlage / *Enclosure* 6.1
Verwendungsbereich / *Application list*

Seite *Page* 15/15

Hersteller / <i>manufacturer</i>	Modell / <i>model</i>	Typ / <i>type</i>	ABE / EG	Jahr / <i>year</i>	Standard / <i>standard</i> Höhe/Breite <i>height / width</i> [mm]	Ausführung / <i>version</i>	Tour / <i>touring</i> Höhe/Breite <i>height / width</i> [mm]	Ausführung / <i>version</i>	Sport / <i>sports</i> Höhe/Breite <i>height / width</i> [mm]	Ausführung / <i>version</i>
Yamaha	FZR 1000 EXUP	3LE/3LF/3GM	F128	89-90	320/400	65344154	370/400	65331105	-	-
	FZR 1000 EXUP	3LE/3LF/3GM	F128	91-93	360/390	65344155	390/390	65331106	-	-
	FZR 1000	3LE/3LF/3GM	F128	94-	320/440	65344156	400/440	65331107	-	-
	FZS 1000 Fazer	RN 06	e1*0103*	01-04	320/300	65341830	350/300	65345087	-	-
	YZF 1000 R	4VD	H443	98-	370/390	65344157	420/390	65331108	-	-
	YZF R1	RN01	H917	98-99	330/290	65344158	350/290	65331109	-	-
	YZF R1	RN04	e1*0063*	00-01	420/330	65344159	450/330	65331110	-	-
	YZF R1	RN09	e13*0054*	02-03	420/300	65341824	450/300	65345088	-	-
	YZF R1	RN12	e13*0084*	04-06	420/300	65344160	450/300	65345081	-	-
	YZF R1	RN19	e13*0163*	07-08	420/370	65344161	440/370	65345093	-	-
	YZF-R1	RN22	e13*0325*	09-14	470/530	65344162	490/530	65345096	-	-
	YZF-R1	RN32	e13*0740*	15-	-	-	370/320	65331111	-	-
	FJ 1200	3CW	E745	88-90	430/320	65344163	440/320	65331112	-	-
	FJ 1200	3CX/3GP/3CV	EBE	88-90	430/320	65344163	440/320	65331112	-	-
	FJ 1200	3YA	F559	91-94	370/440	65344164	440/400	65331113	-	-
	XT 1200 Z Super Tenere	DP01	e13*0388*	10-	-	-	495/410	65332898	-	-
	FJR 1300	RP 04	e13*0045*	01-03	345/550	65344165	375/550	65332893	-	-
	FJR 1300	RP 08	e13*0062*	03-03	345/550	65344165	375/550	65332893	-	-
FJR 1300	RP11	e13*0081*	04-05	370/490	65344165	470/490	65332893	-	-	
FJR 1300	RP13	e13*0041*	05-12	345/550	65344166	375/550	65332895	-	-	
FJR 1300	RP23	e13*0574*	13-15	470/510	65344167	510/510	65332897	-	-	
FJR 1300	RP28	e13*168/2013*0001*	16-	-	-	510/510	65332897	-	-	

Techn.Bericht Nr. /
Techn. Report No.: 11-00086-CM-GBM-30
Hersteller / *Manufacturer:* Fechter-Drive Motorsport GmbH
Art / Kind / Windschild / *Windshield*
Typ / Type 100

Anlage /
Enclosure 6.2

Seite/Page 1/17



BMW CE 04 (350x340)



Honda PCX 125 (440 x 300)

Techn.Bericht Nr. /
Techn. Report No.: 11-00086-CM-GBM-30
Hersteller / *Manufacturer:* Fechter-Drive Motorsport GmbH
Art / Kind / Windschild / *Windshield*
Typ / Type 100

Anlage /
Enclosure 6.2

Seite/Page 2/17



Honda Forza 125 (390 x 425)



Honda Forza 125 (410 x 395)

Techn.Bericht Nr. /
Techn. Report No.: 11-00086-CM-GBM-30
Hersteller / *Manufacturer:* Fechter-Drive Motorsport GmbH
Art / Kind / Windschild / *Windshield*
Typ / Type 100

Anlage /
Enclosure 6.2

Seite/Page 3/17



Honda Forza 300 (390 x 425)



Honda Forza 350 (410 x 395)

Techn.Bericht Nr. /
Techn. Report No.: 11-00086-CM-GBM-30
Hersteller / *Manufacturer:* Fechter-Drive Motorsport GmbH
Art / Kind / Windschild / *Windshield*
Typ / Type 100

Anlage /
Enclosure 6.2

Seite/Page 4/17



Honda Forza 750 (480 x 480)



Honda Integra 750 (485 x485)

Techn.Bericht Nr. /
Techn. Report No.: 11-00086-CM-GBM-30
Hersteller / *Manufacturer:* Fechter-Drive Motorsport GmbH
Art / Kind / Windschild / *Windshield*
Typ / Type 100

Anlage /
Enclosure 6.2

Seite/Page 5/17



Honda NT1100 DCT (600 x 465)



Honda NT1100 DCT (470 x 440)

Techn.Bericht Nr. /
Techn. Report No.: 11-00086-CM-GBM-30
Hersteller / *Manufacturer:* Fechter-Drive Motorsport GmbH
Art / Kind / Windschild / *Windshield*
Typ / Type 100

Anlage /
Enclosure 6.2

Seite/Page 6/17



Kymco AK 550i (490 x 400)



Kymco DT X360 125i / 350i (370 x 330)

Techn.Bericht Nr. /
Techn. Report No.: 11-00086-CM-GBM-30
Hersteller / *Manufacturer:* Fechter-Drive Motorsport GmbH
Art / Kind / Windschild / *Windshield*
Typ / Type 100

Anlage /
Enclosure 6.2

Seite/Page 7/17



KymcoNew Downtown 125 / 350 (490 x 355)



Kymco Xciting S 400i (450 x 400)

Techn.Bericht Nr. /
Techn. Report No.: 11-00086-CM-GBM-30
Hersteller / *Manufacturer:* Fechter-Drive Motorsport GmbH
Art / Kind / Windschild / *Windshield*
Typ / Type 100

Anlage /
Enclosure 6.2

Seite/Page 8/17



Kymco X-Town 125 / 300 (430 x 390)



Peugeot Metropolis 400 (420 x 430)

Techn.Bericht Nr. /
Techn. Report No.: 11-00086-CM-GBM-30
Hersteller / *Manufacturer:* Fechter-Drive Motorsport GmbH
Art / Kind / Windschild / *Windshield*
Typ / Type 100

Anlage /
Enclosure 6.2

Seite/Page 9/17



Piaggio MP3 300 HPE / Sport (590 x 400)



Piaggio MP3 350 / 500 HPE / Sport (510 x 485)

Techn.Bericht Nr. /
Techn. Report No.: 11-00086-CM-GBM-30
Hersteller / *Manufacturer:* Fechter-Drive Motorsport GmbH
Art / Kind / Windschild / *Windshield*
Typ / Type 100

Anlage /
Enclosure 6.2

Seite/Page 10/17



Suzuki AN 400 Burgman (440 x 370)



Suzuki GSX-S 1000 GT (495x390)

Techn.Bericht Nr. /
Techn. Report No.: 11-00086-CM-GBM-30
Hersteller / *Manufacturer:* Fechter-Drive Motorsport GmbH
Art / Kind / Windschild / *Windshield*
Typ / Type 100

Anlage /
Enclosure 6.2

Seite/Page 11/17



SYM Cruisym 125 / 300 (500 x 380)



SYM Cruisym 125 / 300 (550 x 430)

Techn.Bericht Nr. /
Techn. Report No.: 11-00086-CM-GBM-30
Hersteller / *Manufacturer:* Fechter-Drive Motorsport GmbH
Art / Kind / Windschild / *Windshield*
Typ / Type 100

Anlage /
Enclosure 6.2

Seite/Page 12/17



SYM Joymax Z 125 / 300 (400 x 380)



Joymax Z+ 125 / 300 (550 x 430)

Techn.Bericht Nr. /
Techn. Report No.: 11-00086-CM-GBM-30
Hersteller / *Manufacturer:* Fechter-Drive Motorsport GmbH
Art / Kind / Windschild / *Windshield*
Typ / Type 100

Anlage /
Enclosure 6.2

Seite/Page 13/17



SYM Maxsym 500 LT (470 x 420)



Yamaha T-Max 560 (360 x 450)

Techn.Bericht Nr. /
Techn. Report No.: 11-00086-CM-GBM-30
Hersteller / *Manufacturer:* Fechter-Drive Motorsport GmbH
Art / Kind / Windschild / *Windshield*
Typ / Type 100

Anlage /
Enclosure 6.2

Seite/Page 14/17



Yamaha T-Max 560 (405 x 450)



Yamaha X-Max 125 (410 x 395)

Techn.Bericht Nr. /
Techn. Report No.: 11-00086-CM-GBM-30
Hersteller / *Manufacturer:* Fechter-Drive Motorsport GmbH
Art / Kind / Windschild / *Windshield*
Typ / Type 100

Anlage /
Enclosure 6.2

Seite/Page 15/17



Yamaha X-Max 300 (410 x 395)



Yamaha X-Max 400 (410 x 395)

Techn.Bericht Nr. /
Techn. Report No.: 11-00086-CM-GBM-30
Hersteller / *Manufacturer:* Fechter-Drive Motorsport GmbH
Art / Kind / Windschild / *Windshield*
Typ / Type 100

Anlage /
Enclosure 6.2

Seite/Page 16/17



Yamaha Tricity 125 (350 x 380)



Yamaha Tricity 300 (410 x 395)

Techn.Bericht Nr. /
Techn. Report No.: 11-00086-CM-GBM-30
Hersteller / *Manufacturer:* Fechter-Drive Motorsport GmbH
Art / Kind / Windschild / *Windshield*
Typ / Type 100

Anlage /
Enclosure 6.2

Seite/Page 17/17



Yamaha Tracer 9 / GT (360x360)

(Maßangaben in mm)



FICHE PRODUIT ERMAX

HONDA

125/250/300 FORZA (ELECTRIQUE) 2018 - PB SPORT



Consignes de finition - Description du produit

Sérigraphie	Oui <input type="checkbox"/>	Non <input checked="" type="checkbox"/>	Peinte	<input type="checkbox"/>
Joint	Oui <input type="checkbox"/>	Non <input checked="" type="checkbox"/>		
Kit fixation	Oui <input type="checkbox"/>	Non <input checked="" type="checkbox"/>	Sans notice	<input type="checkbox"/>
Détail kit sans notice	-			
Autocollant	Ermax Sport			
Emballage	Sous skin			
Hauteur	39 cm	Largeur	42,5 cm	Nb trous fix. 4
Options possibles	Sérigraphies décoratives			
Spécial				
Code article	65347008			

Service qualité - 24/01/2019



FICHE PRODUIT ERMAX

HONDA

125/250/300 FORZA (ELECTRIQUE) 2018 - PB SPORT



Consignes de finition - Description du produit

Sérigraphie	Oui <input type="checkbox"/>	Non <input checked="" type="checkbox"/>	Peinte	<input type="checkbox"/>
Joint	Oui <input type="checkbox"/>	Non <input checked="" type="checkbox"/>		
Kit fixation	Oui <input type="checkbox"/>	Non <input checked="" type="checkbox"/>	Sans notice	<input type="checkbox"/>
Détail kit sans notice	-			
Autocollant	Ermax Sport			
Emballage	Sous skin			
Hauteur	39 cm	Largeur	42,5 cm	Nb trous fix. 4
Options possibles	Sérigraphies décoratives			
Spécial				
Code article	65347029			

Service qualité - 24/01/2019



FICHE PRODUIT ERMAX

HONDA

125 PCX 2018 - PB SPORT

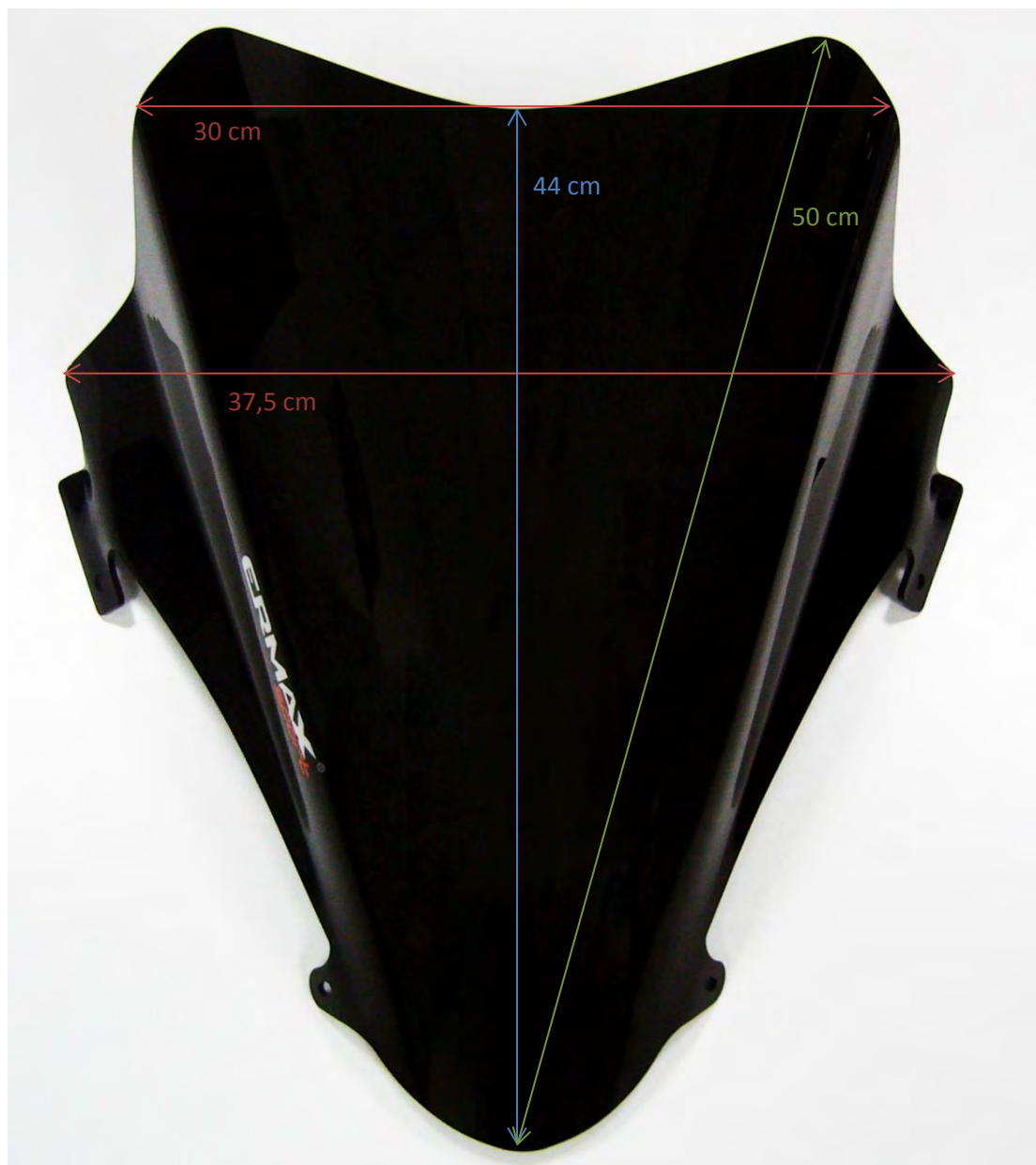

Consignes de finition - Description du produit

Sérigraphie	Oui <input type="checkbox"/>	Non <input checked="" type="checkbox"/>	Peinte	<input type="checkbox"/>
Joint	Oui <input type="checkbox"/>	Non <input checked="" type="checkbox"/>		
Kit fixation	Oui <input checked="" type="checkbox"/>	Non <input type="checkbox"/>	Sans notice	<input type="checkbox"/>
Détail kit sans notice	-			
Autocollant	Ermax Sport			
Emballage	Sous skin			
Hauteur	44 cm	Largeur	30 cm	Nb trous fix. 4
Options possibles	Sérigraphies décoratives			
Spécial	-			
Code article	65347034			

Service qualité - 19/02/2019



FICHE PRODUIT ERMAX

KYMCO

AK 550 2017 - PB SPORT



Consignes de finition - Description du produit

Sérigraphie	Oui <input type="checkbox"/>	Non <input checked="" type="checkbox"/>	Peinte	<input type="checkbox"/>
Joint	Oui <input type="checkbox"/>	Non <input checked="" type="checkbox"/>		
Kit fixation	Oui <input checked="" type="checkbox"/>	Non <input type="checkbox"/>	Sans notice	<input type="checkbox"/>
Détail kit sans notice	-			
Autocollant	Ermax Sport			
Emballage	Sac plastique + sac mousse			
Hauteur	49 cm	Largeur	40 cm	Nb trous fix. 4
Options possibles	-			
Spécial				
Code article	65347049			

Service qualité - 31/08/2017



FICHE PRODUIT ERMAX

KYMCO

125I/350I DOWNTOWN 2015 - SUPER DINK 125I 2018 - PB SPORT

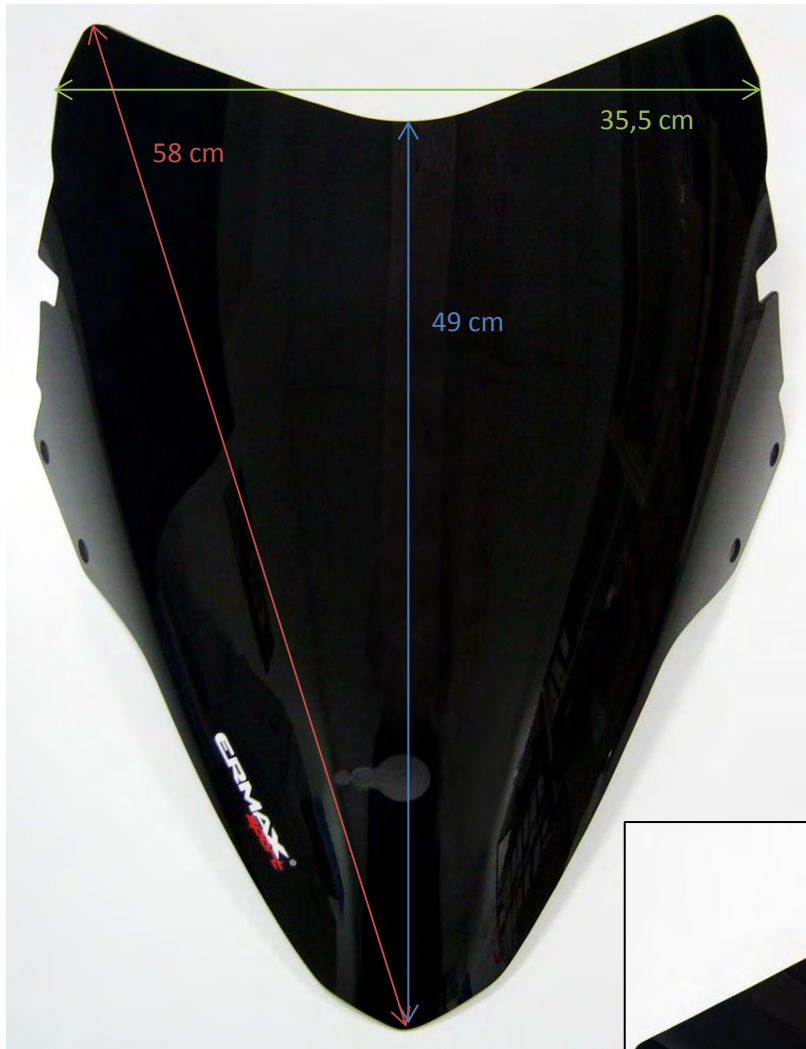

Consignes de finition - Description du produit

Sérigraphie	Oui <input type="checkbox"/>	Non <input checked="" type="checkbox"/>	Peinte	<input type="checkbox"/>
Joint	Oui <input type="checkbox"/>	Non <input checked="" type="checkbox"/>		
Kit fixation	Oui <input checked="" type="checkbox"/>	Non <input type="checkbox"/>	Sans notice	<input type="checkbox"/>
Détail kit sans notice	-			
Autocollant	Ermax Sport			
Emballage	1 sac mousse + 1 sac transparent			
Hauteur	49 cm	Largeur	35,5 cm	Nb trous fix. 4
Options possibles	Sérigraphies décoratives			
Spécial				
Code article	65347057			

Service qualité - 24/07/2018 - M.à.j 17/09/2018



FICHE PRODUIT ERMAX

KYMCO

X CITING S 400I 2018 - PB SPORT

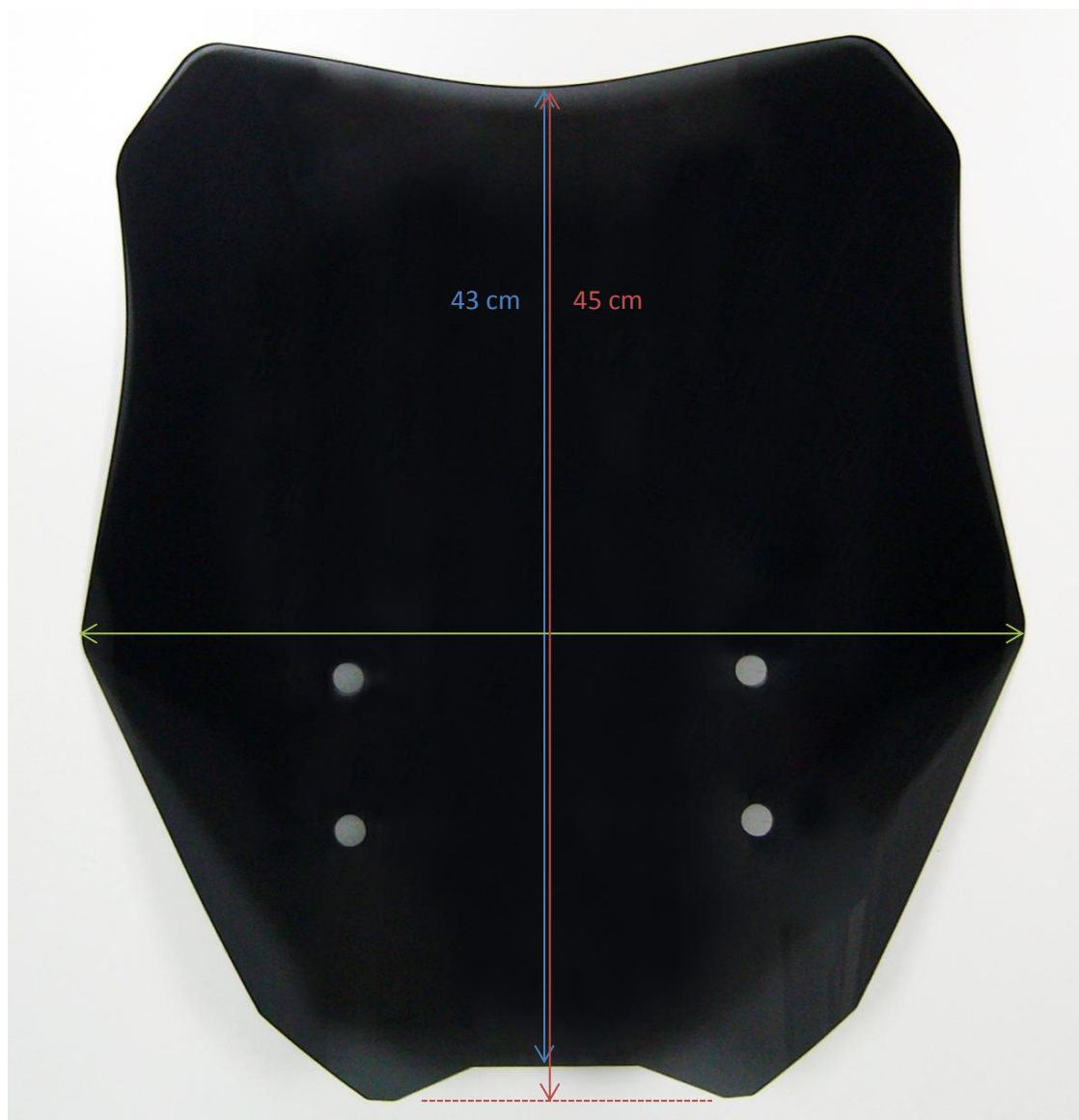

Consignes de finition - Description du produit

Sérigraphie	Oui <input checked="" type="checkbox"/>	Non <input type="checkbox"/>	Peinte	<input type="checkbox"/>
Joint	Oui <input type="checkbox"/>	Non <input checked="" type="checkbox"/>		
Kit fixation	Oui <input checked="" type="checkbox"/>	Non <input type="checkbox"/>	Sans notice	<input type="checkbox"/>
Détail kit sans notice	-			
Autocollant	Ermax Sport			
Emballage	Sous skin			
Hauteur	45 cm	Largeur	40 cm	Nb trous fix. 4
Options possibles	Sérigraphies décoratives			
Spécial				
Code article	65347064			

Service qualité - 13/09/2019



Kit de fixation :	Oui		
Particularité de finition :	Autocollant Ermamax sport bi color		
Sérigraphie :	Oui		
Hauteur :	430 mm	Largeur :	390 mm (au plus large)
Nb de trous de fixation :	7		
Epaisseur de fabrication :	3 mm		
Spécificités :	-		
Code article :	65347066		



FICHE PRODUIT ERMAX

PEUGEOT

METROPOLIS 400 I 2013 - PARE BRISE SPORT

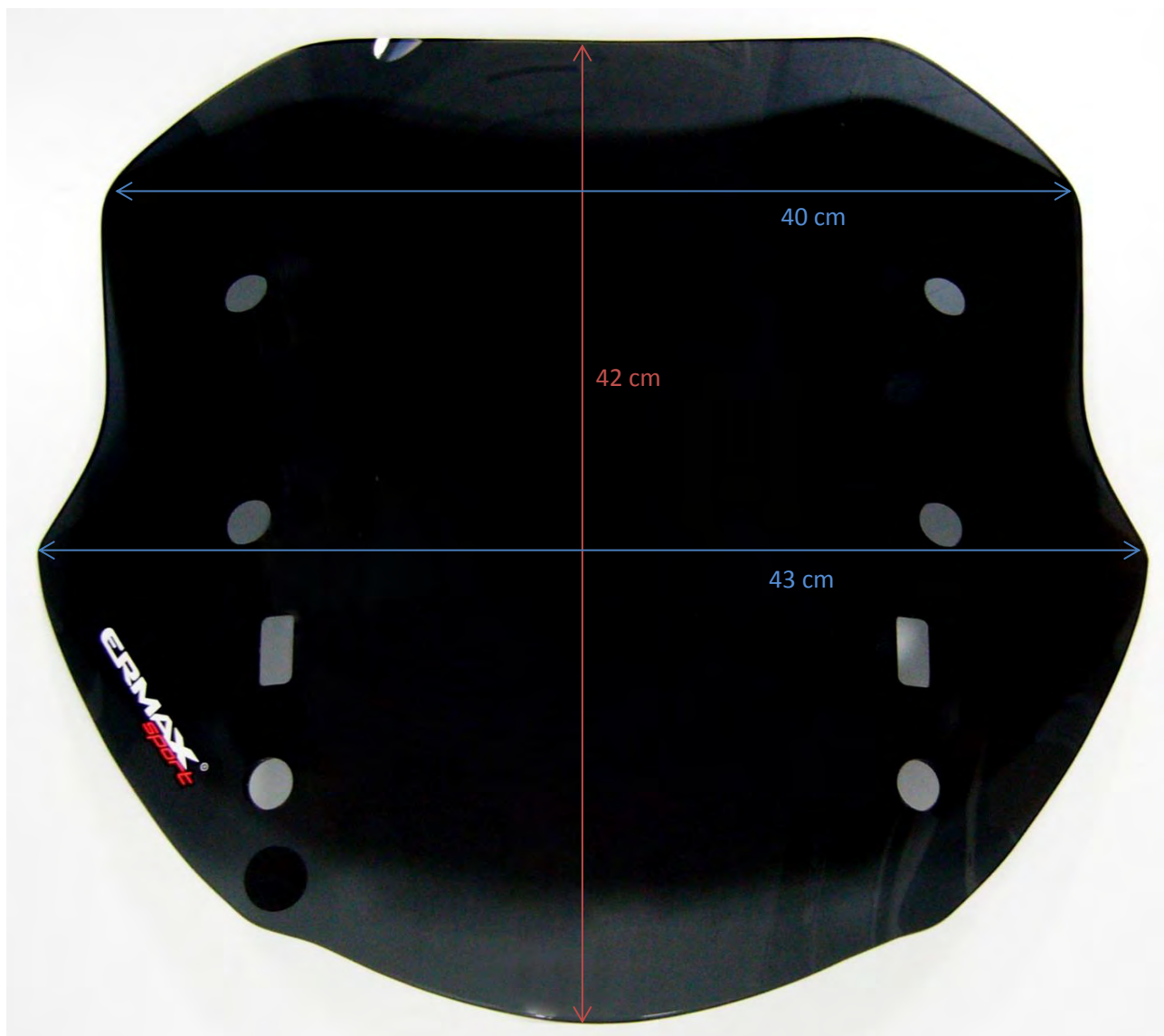

Consignes de finition - Description du produit

Sérigraphie	Oui <input type="checkbox"/>	Non <input checked="" type="checkbox"/>	Peinte	<input type="checkbox"/>
Joint	Oui <input type="checkbox"/>	Non <input checked="" type="checkbox"/>		
Kit fixation	Oui <input type="checkbox"/>	Non <input checked="" type="checkbox"/>	Sans notice	<input type="checkbox"/>
Détail kit sans notice	-			
Autocollant	Ermax Sport			
Emballage	1 sac mousse + 1 sac transparent			
Hauteur	42 cm	Largeur	43 cm	Nb trous fix. 8
Options possibles	Sérigraphies décoratives			
Spécial	-			
Code article	65347076			

Service qualité - 10/06/2020



FICHE PRODUIT ERMAX

PIAGGIO

MP3 300 HPE 2019 - PB SPORT TOURING



Consignes de finition - Description du produit

Sérigraphie	Oui <input type="checkbox"/>	Non <input checked="" type="checkbox"/>	Peinte	<input type="checkbox"/>
Joint	Oui <input type="checkbox"/>	Non <input checked="" type="checkbox"/>		
Kit fixation	Oui <input type="checkbox"/>	Non <input checked="" type="checkbox"/>	Sans notice	<input type="checkbox"/>
Détail kit sans notice	-			
Autocollant	Ermax			
Emballage	1 sac mousse + 1 sac transparent			
Hauteur	59 cm	Largeur	40 cm	Nb trous fix. 4
Options possibles	Sérigraphies décoratives			
Spécial				
Code article	65347085			

Service qualité - 07/02/2020



FICHE PRODUIT ERMAX

PIAGGIO

MP3 500 HPE 2018 - PB SPORT

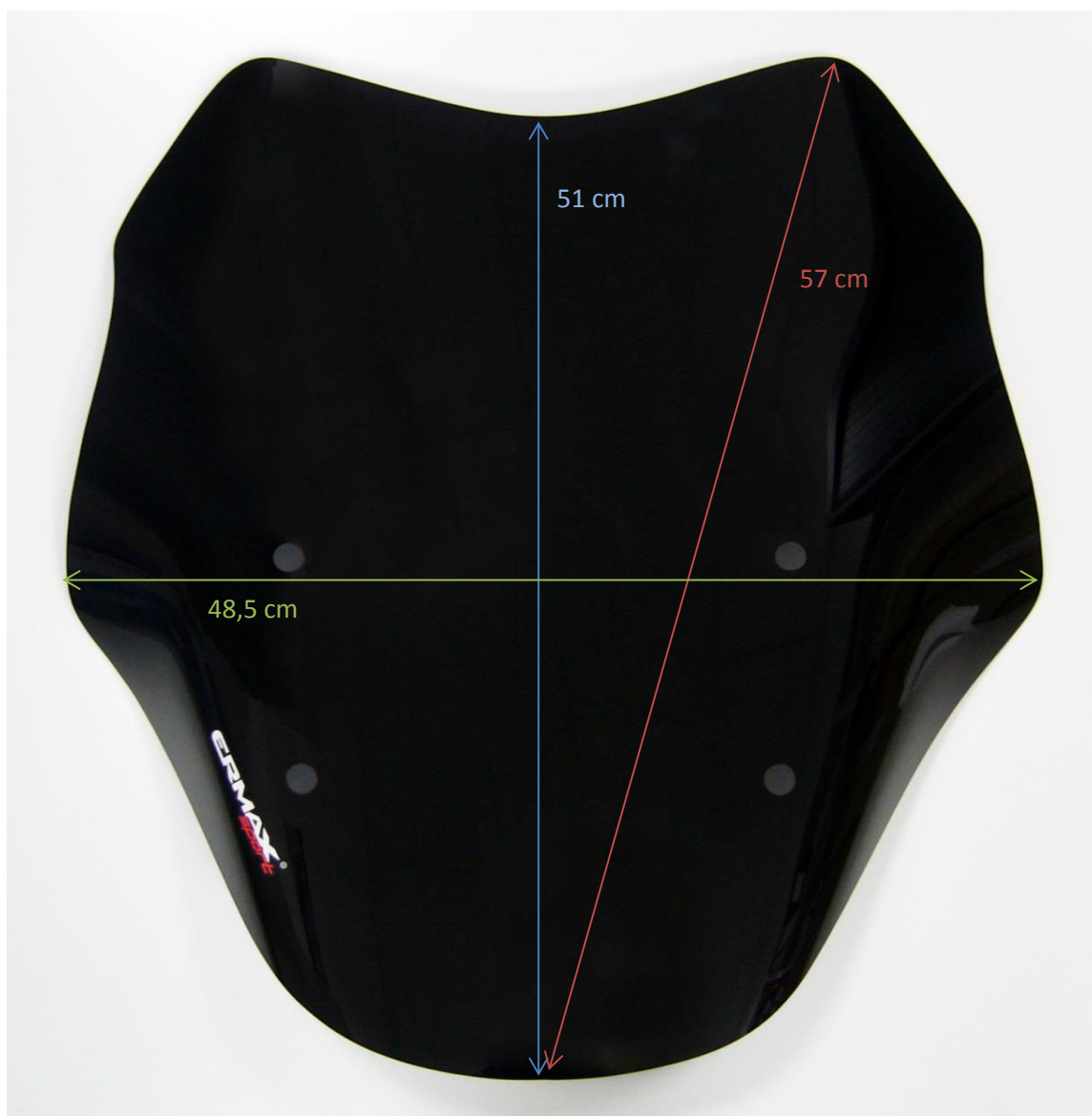

Consignes de finition - Description du produit

Sérigraphie	Oui <input type="checkbox"/>	Non <input checked="" type="checkbox"/>	Peinte	<input type="checkbox"/>
Joint	Oui <input type="checkbox"/>	Non <input checked="" type="checkbox"/>		
Kit fixation	Oui <input type="checkbox"/>	Non <input checked="" type="checkbox"/>	Sans notice	<input type="checkbox"/>
Détail kit sans notice	-			
Autocollant	Ermax Sport			
Emballage	1 sac mousse + 1 sac transparent			
Hauteur	51 cm	Largeur	48,5 cm	Nb trous fix. 4
Options possibles	Sérigraphies décoratives			
Spécial				
Code article	65347089			

Service qualité - 04/07/2018



FICHE PRODUIT ERMAX

SUZUKI

400 BURGMAN 2017 - PB SPORT

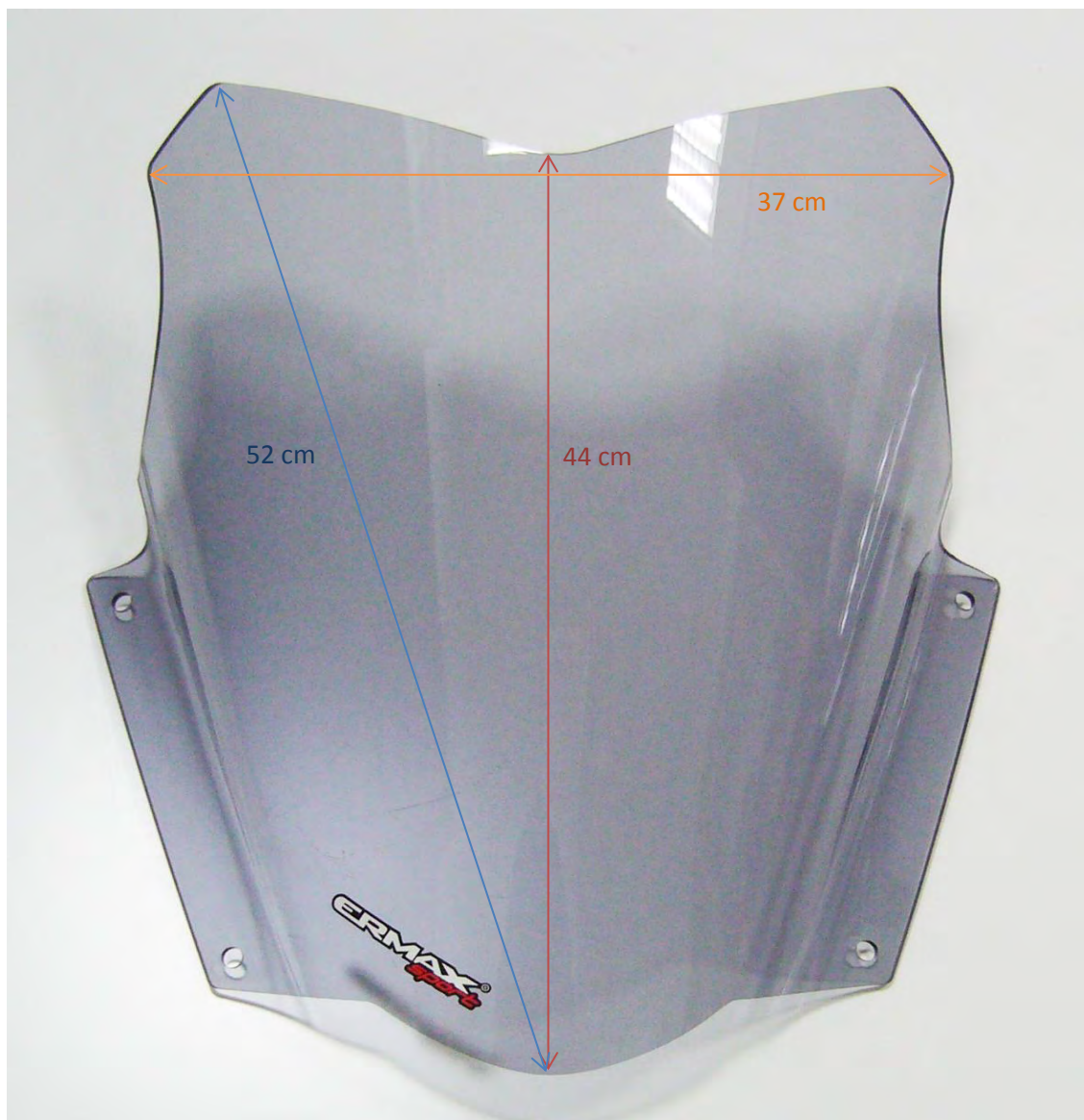

Consignes de finition - Description du produit

Sérigraphie	Oui <input type="checkbox"/>	Non <input checked="" type="checkbox"/>	Peinte	<input type="checkbox"/>
Joint	Oui <input type="checkbox"/>	Non <input checked="" type="checkbox"/>		
Kit fixation	Oui <input type="checkbox"/>	Non <input checked="" type="checkbox"/>	Sans notice	<input type="checkbox"/>
Détail kit sans notice	-			
Autocollant	Ermax sport			
Emballage	1 sac mousse + 1 sac plastique			
Hauteur	44 cm	Largeur	37 cm	Nb trous fix. 4
Options possibles	Sérigraphies décoratives			
Spécial				
Code article	65347112			

Service qualité - 19/03/18



FICHE PRODUIT ERM MAX

SYM

CRUISYM 300 2018 - BULLE SPORT

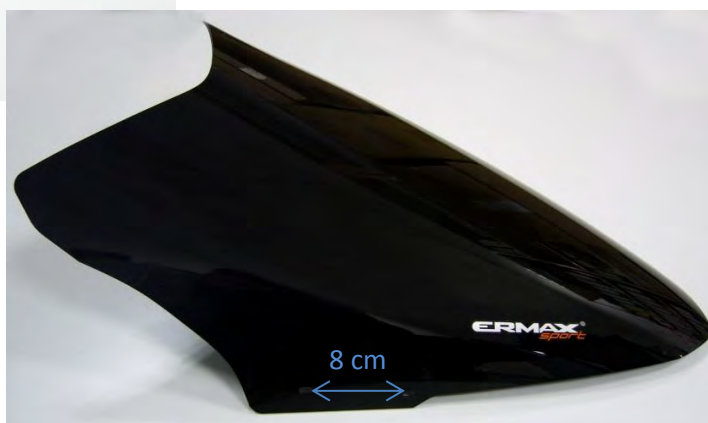
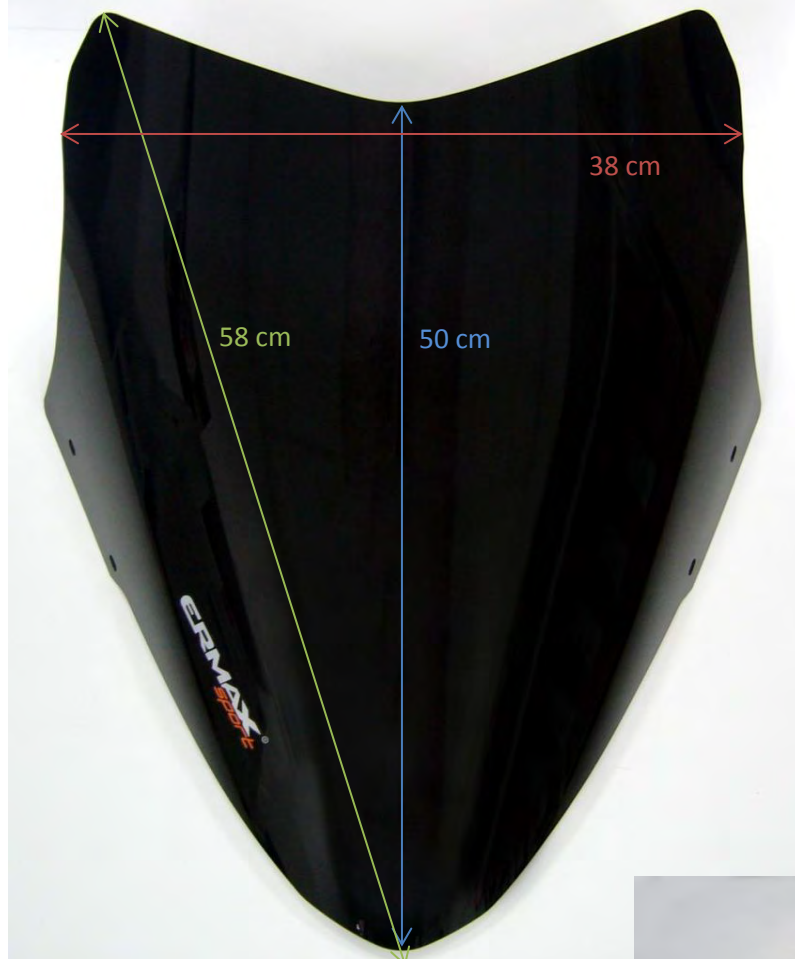

Consignes de finition - Description du produit

Sérigraphie	Oui <input type="checkbox"/>	Non <input checked="" type="checkbox"/>	Peinte	<input type="checkbox"/>
Joint	Oui <input type="checkbox"/>	Non <input checked="" type="checkbox"/>		
Kit fixation	Oui <input checked="" type="checkbox"/>	Non <input type="checkbox"/>	Sans notice	<input type="checkbox"/>
Détail kit sans notice	-			
Autocollant	Ermax Sport			
Emballage	1 sac mousse + 1 sac transparent			
Hauteur	50 cm	Largeur	38 cm	Nb trous fix. 4
Options possibles	Sérigraphies décoratives			
Spécial	Livré avec pattes de fixation métalliques			
Code article	65347114			

Service qualité - 27/11/2018



FICHE PRODUIT ERMAX

SYM

JOYMAX Z 125/300 2019 - PB SPORT

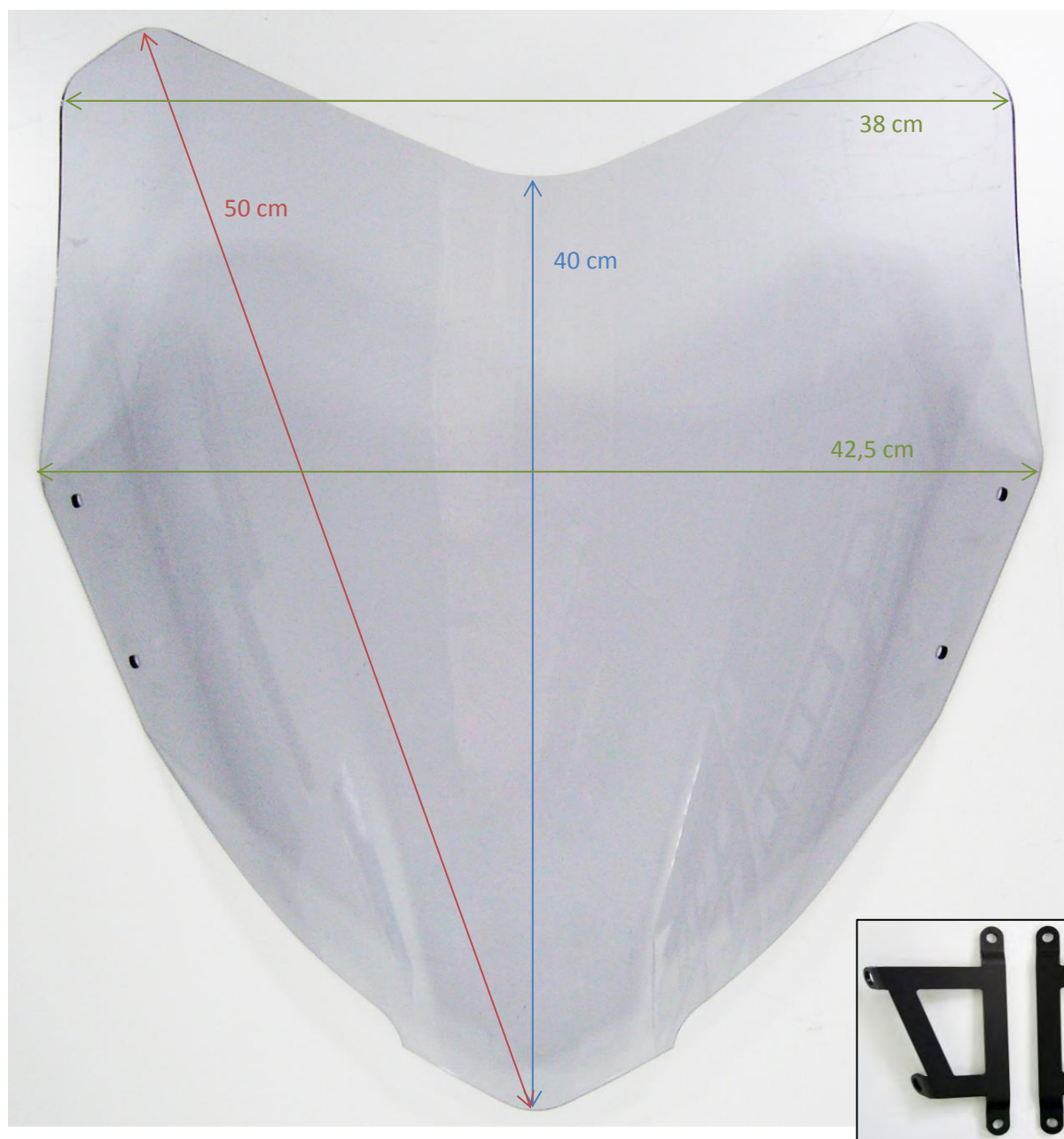

Consignes de finition - Description du produit

Sérigraphie	Oui <input type="checkbox"/>	Non <input checked="" type="checkbox"/>	Peinte	<input type="checkbox"/>	
Joint	Oui <input type="checkbox"/>	Non <input checked="" type="checkbox"/>			
Kit fixation	Oui <input checked="" type="checkbox"/>	Non <input type="checkbox"/>	Sans notice	<input type="checkbox"/>	
Détail kit sans notice	-				
Autocollant	Ermax Sport				
Emballage	1 sac mousse + 1 sac transparent				
Hauteur	40 cm	Largeur	38 cm	Nb trous fix.	4
Options possibles	Sérigraphies décoratives				
Spécial	Livré avec 2 pattes métalliques				
Code article	65347116				

Service qualité - 01/07/2020



FICHE PRODUIT ERMAX

SYM

MAXSYM 500 TL 2020 - PB SPORT



Consignes de finition - Description du produit

Sérigraphie	Oui <input checked="" type="checkbox"/>	Non <input type="checkbox"/>	Peinte	<input type="checkbox"/>
Joint	Oui <input type="checkbox"/>	Non <input checked="" type="checkbox"/>		
Kit fixation	Oui <input checked="" type="checkbox"/>	Non <input type="checkbox"/>	Sans notice	<input type="checkbox"/>
Détail kit sans notice	-			
Autocollant	Ermax Sport			
Emballage	1 sac mousse + 1 sac transparent			
Hauteur	47 cm	Largeur	42 cm	Nb trous fix. 4
Options possibles	Sérigraphies décoratives			
Spécial				
Code article	65347118			

Service qualité - 15/10/2020



FICHE PRODUIT ERMAX

YAMAHA

530 TMAX 2017/2019 - 560 TMAX 2020 - PB SPORT

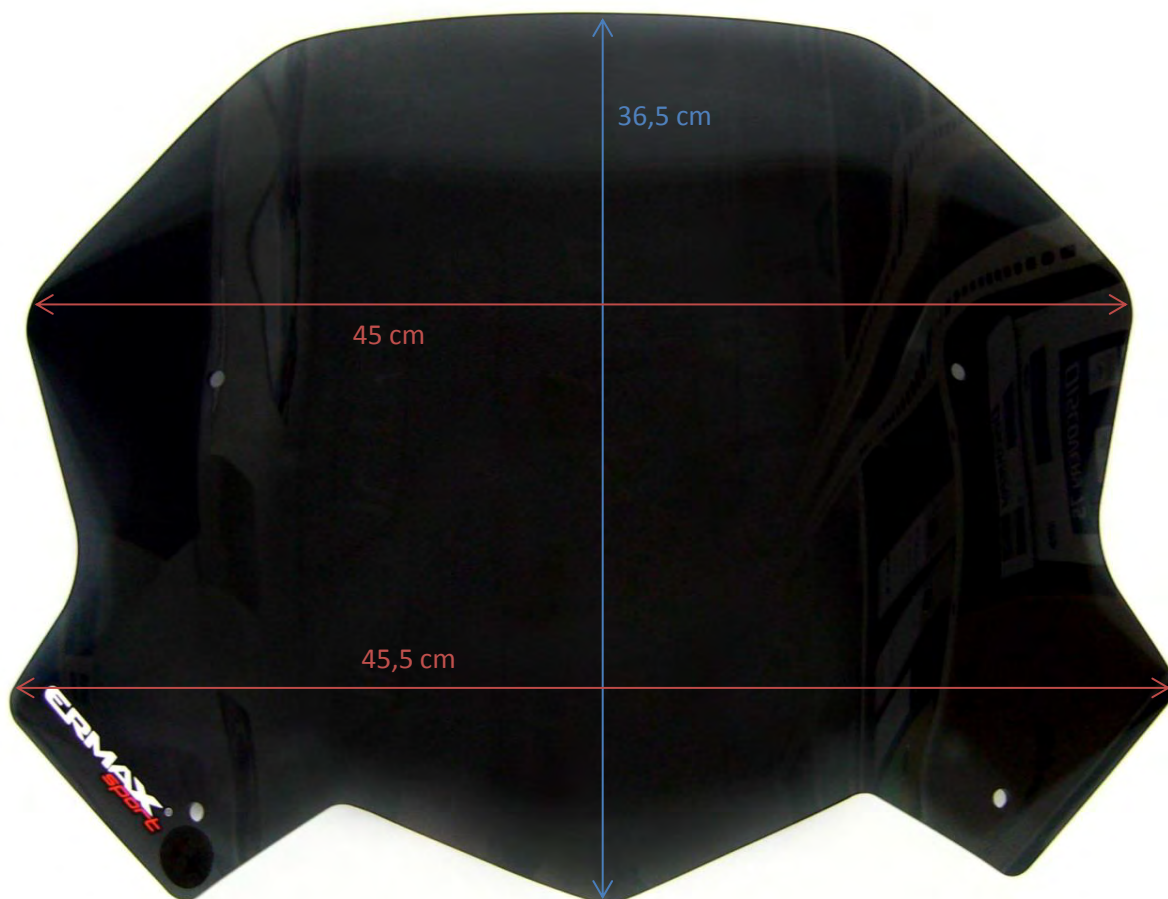

Consignes de finition - Description du produit

Sérigraphie	Oui <input type="checkbox"/>	Non <input checked="" type="checkbox"/>	Peinte	<input type="checkbox"/>
Joint	Oui <input type="checkbox"/>	Non <input checked="" type="checkbox"/>		
Kit fixation	Oui <input type="checkbox"/>	Non <input type="checkbox"/>	Sans notice	<input checked="" type="checkbox"/>
Détail kit sans notice	4 entretoises caoutchouc 6x5 + 4 vis 5x20 noires grosse tête + 4 rondelles nylon Ø 5			
Autocollant	Ermax Sport			
Emballage	1 sac transparent + 1 sac mousse			
Hauteur	36 cm	Largeur	45 cm	Nb trous fix. 4
Options possibles	Sérigraphies décoratives			
Spécial				
Code article	65347122			

Service qualité - 02/06/2017 - M.à.j 05/07/2017 - M.à.j 20/12/2019



FICHE PRODUIT ERMAX

YAMAHA

300 XMAX 2017 - 125/400 XMAX 2018 - PB SPORT

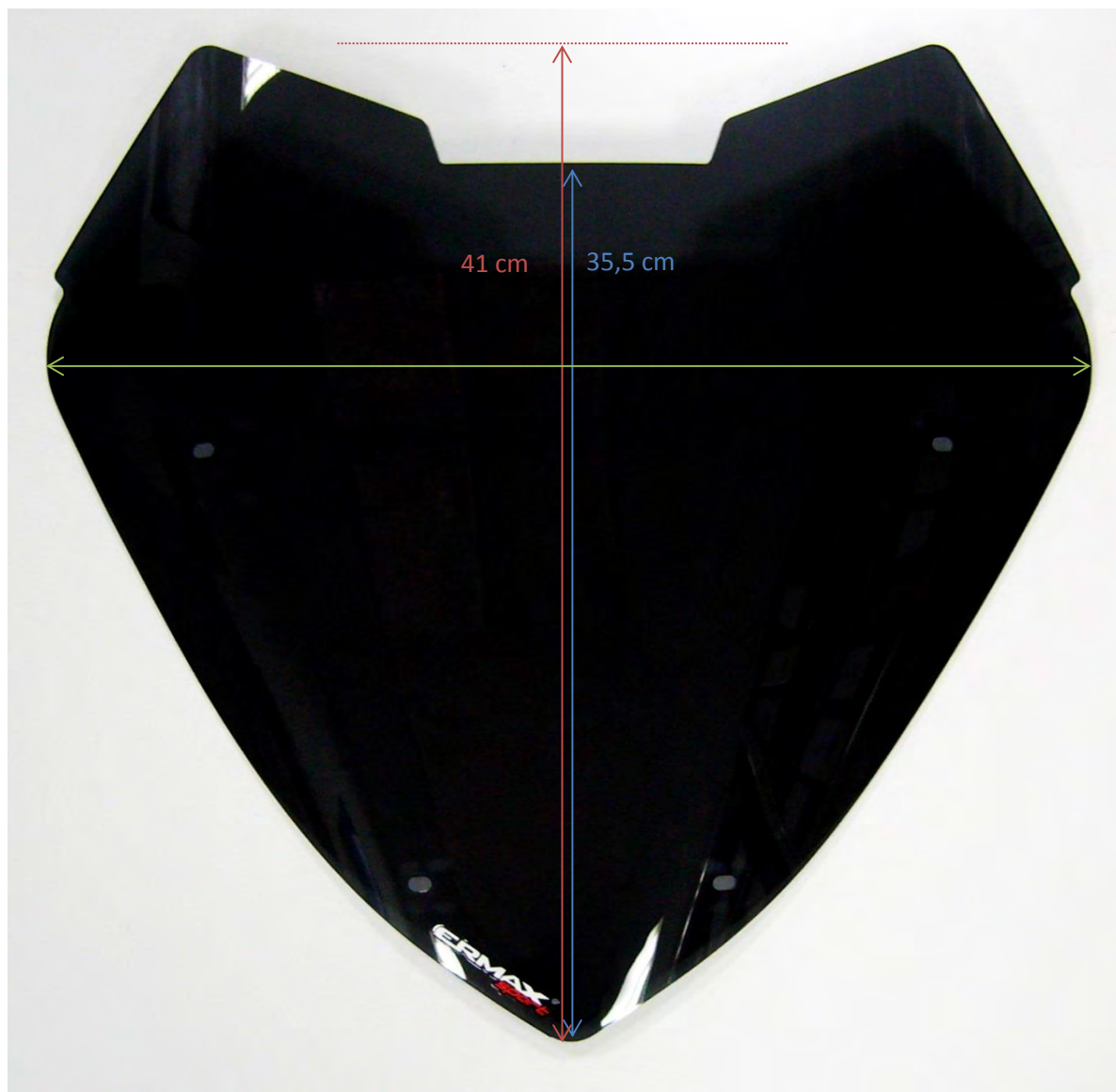

Consignes de finition - Description du produit

Sérigraphie	Oui <input type="checkbox"/>	Non <input checked="" type="checkbox"/>	Peinte	<input type="checkbox"/>
Joint	Oui <input type="checkbox"/>	Non <input checked="" type="checkbox"/>		
Kit fixation	Oui <input checked="" type="checkbox"/>	Non <input type="checkbox"/>	Sans notice	<input type="checkbox"/>
Détail kit sans notice	-			
Autocollant	Ermamax Sport			
Emballage	Skinpack			
Hauteur	41 cm	Largeur	39,5 cm	Nb trous fix. 4
Options possibles	Sérigraphies décoratives			
Spécial				
Code article	65347126			

Service qualité - 25/09/2017 - M.à.j 21/12/2017



FICHE PRODUIT ERMAX

YAMAHA

300 XMAX 2017 - 125/400 XMAX 2018 - PB SPORT

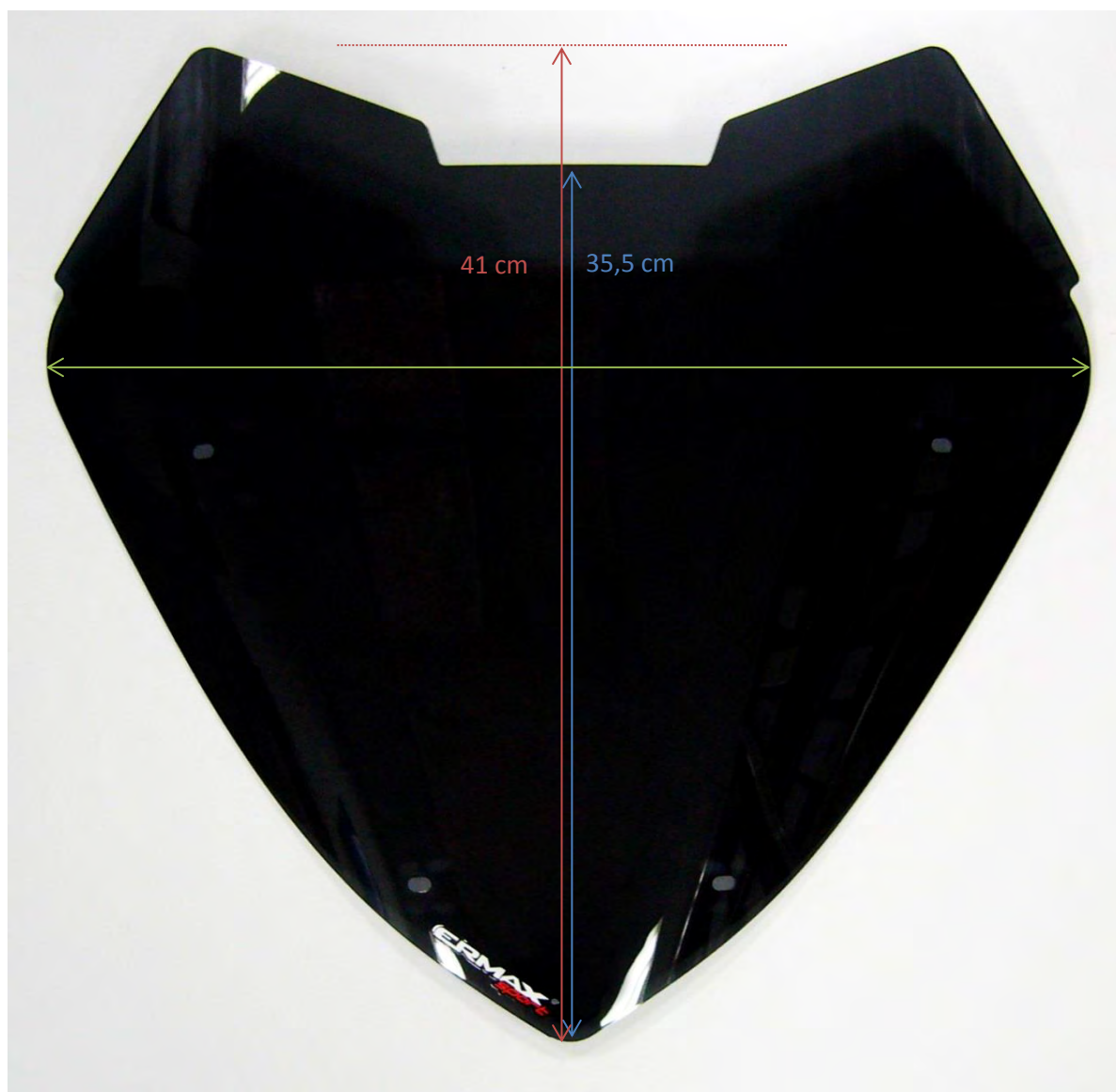

Consignes de finition - Description du produit

Sérigraphie	Oui <input type="checkbox"/>	Non <input checked="" type="checkbox"/>	Peinte	<input type="checkbox"/>
Joint	Oui <input type="checkbox"/>	Non <input checked="" type="checkbox"/>		
Kit fixation	Oui <input checked="" type="checkbox"/>	Non <input type="checkbox"/>	Sans notice	<input type="checkbox"/>
Détail kit sans notice	-			
Autocollant	Ermamax Sport			
Emballage	Skinpack			
Hauteur	41 cm	Largeur	39,5 cm	Nb trous fix. 4
Options possibles	Sérigraphies décoratives			
Spécial				
Code article	65347128			

Service qualité - 25/09/2017 - M.à.j 21/12/2017



FICHE PRODUIT ERMAX

YAMAHA

300 XMAX 2017 - 125/400 XMAX 2018 - PB SPORT

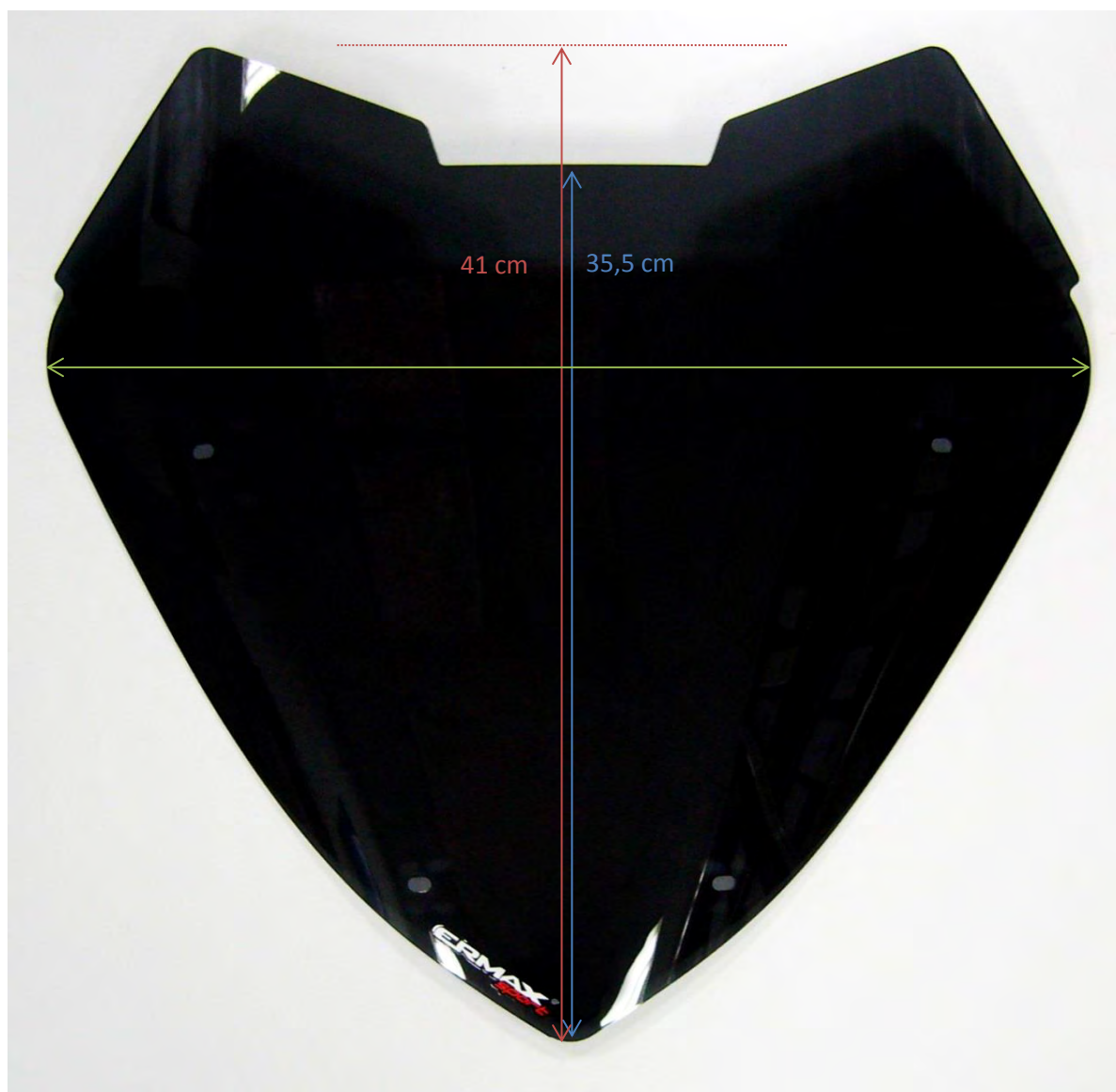

Consignes de finition - Description du produit

Sérigraphie	Oui <input type="checkbox"/>	Non <input checked="" type="checkbox"/>	Peinte	<input type="checkbox"/>
Joint	Oui <input type="checkbox"/>	Non <input checked="" type="checkbox"/>		
Kit fixation	Oui <input checked="" type="checkbox"/>	Non <input type="checkbox"/>	Sans notice	<input type="checkbox"/>
Détail kit sans notice	-			
Autocollant	Ermax Sport			
Emballage	Skinpack			
Hauteur	41 cm	Largeur	39,5 cm	Nb trous fix. 4
Options possibles	Sérigraphies décoratives			
Spécial				
Code article	65347132			

Service qualité - 25/09/2017 - M.à.j 21/12/2017



FICHE PRODUIT ERMAX

HONDA

700 INTEGRA 12/13 - 750 INTEGRA 2014 - PB SPORT



Consignes de finition - Description du produit

Sérigraphie	Oui <input type="checkbox"/>	Non <input checked="" type="checkbox"/>	Peinte	<input type="checkbox"/>
Joint	Oui <input type="checkbox"/>	Non <input checked="" type="checkbox"/>		
Kit fixation	Oui <input type="checkbox"/>	Non <input checked="" type="checkbox"/>	Sans notice	<input type="checkbox"/>
Détail kit sans notice	-			
Autocollant	Ermax Sport			
Emballage	Sac transparent + sac mousse			
Hauteur	48,5 cm	Largeur	48,5 cm	Nb trous fix. 4
Options possibles	Sérigraphies décoratives			
Spécial	-			
Code article	65347134			

Service qualité - 24/09/2012 - M.à.j 20/08/2020



FICHE PRODUIT ERMAX

YAMAHA

125 TRICITY 2014 - PARE BRISE SPORT



Consignes de finition - Description du produit

Sérigraphie	Oui <input type="checkbox"/>	Non <input checked="" type="checkbox"/>	Peinte	<input type="checkbox"/>
Joint	Oui <input type="checkbox"/>	Non <input checked="" type="checkbox"/>		
Kit fixation	Oui <input type="checkbox"/>	Non <input checked="" type="checkbox"/>	Sans notice	<input type="checkbox"/>
Détail kit sans notice	-			
Autocollant	Ermax Sport			
Emballage	Sous skin			
Hauteur	35 cm	Largeur	38 cm	Nb trous fix. 4
Options possibles	Sérigraphies décoratives			
Spécial	-			
Code article	65347138			

Service qualité - 05/09/2014



FICHE PRODUIT ERMAX

YAMAHA

300 XMAX 2017 - 125/400 XMAX 2018 - TRICITY 2020 - PB SPORT

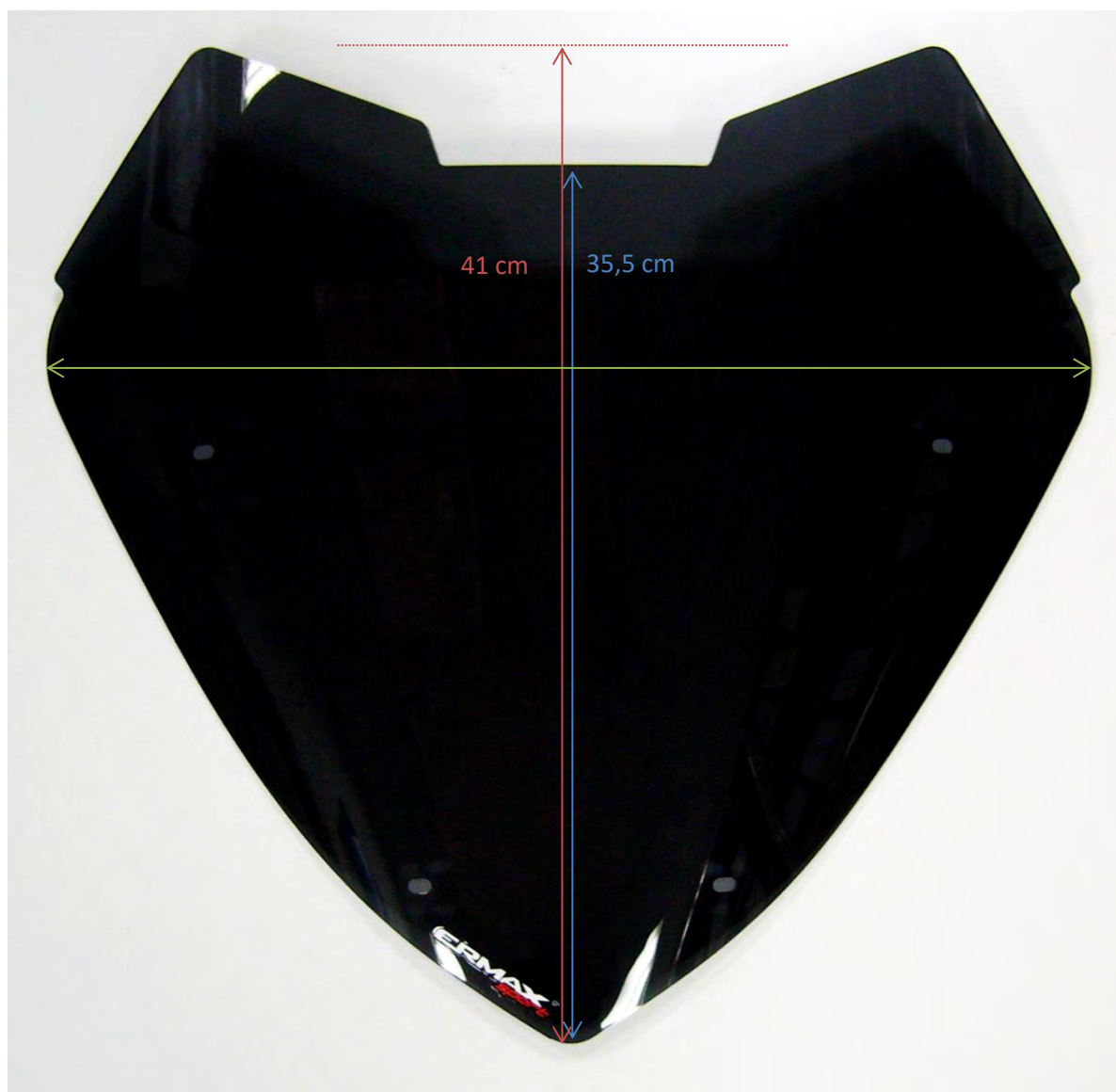

Consignes de finition - Description du produit

Sérigraphie	Oui <input type="checkbox"/>	Non <input checked="" type="checkbox"/>	Peinte	<input type="checkbox"/>
Joint	Oui <input type="checkbox"/>	Non <input checked="" type="checkbox"/>		
Kit fixation	Oui <input checked="" type="checkbox"/>	Non <input type="checkbox"/>	Sans notice	<input type="checkbox"/>
Détail kit sans notice	-			
Autocollant	Ermax Sport			
Emballage	Skinpack			
Hauteur	41 cm	Largeur	39,5 cm	Nb trous fix. 4
Options possibles	Sérigraphies décoratives			
Spécial	Notice spécifique au PB Sport / TO / HP			
Code article	65347140			

Service qualité - 25/09/2017 - M.à.j 05/10/2020



FICHE PRODUIT ERMAX

BMW

CE 04 2022 - SAUTE-VENT SPORT

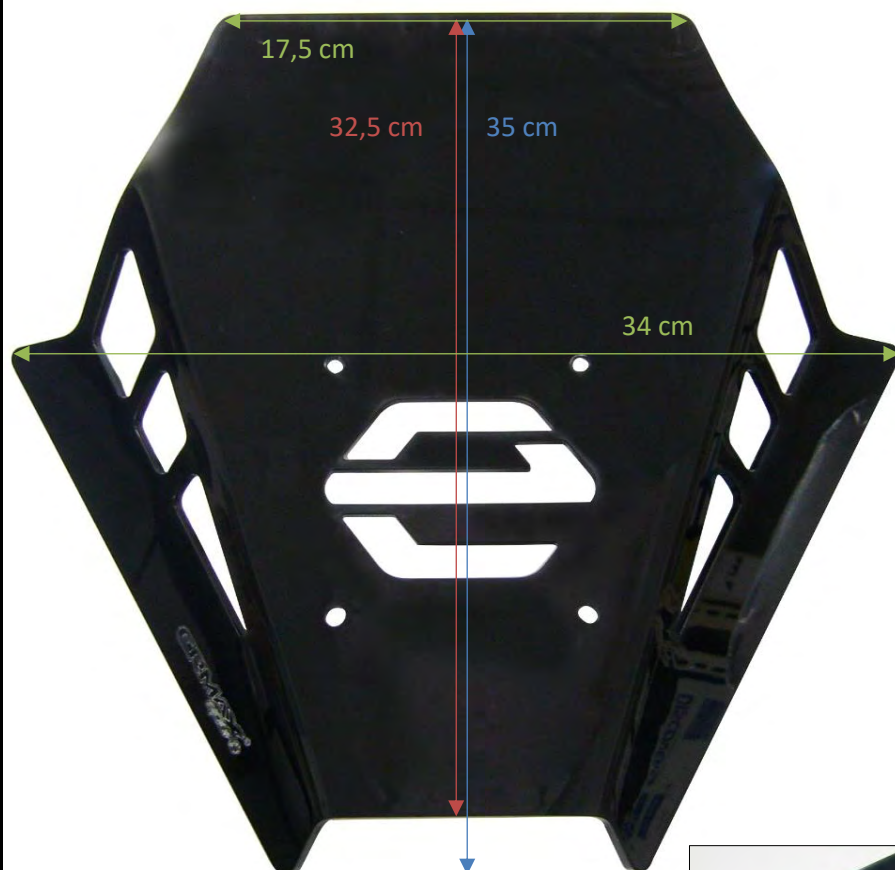

Consignes de finition - Description du produit

Sérigraphie	Oui <input type="checkbox"/>	Non <input checked="" type="checkbox"/>	Peinte	<input type="checkbox"/>
Joint	Oui <input type="checkbox"/>	Non <input checked="" type="checkbox"/>		
Kit fixation	Oui <input type="checkbox"/>	Non <input type="checkbox"/>	Sans notice	<input checked="" type="checkbox"/>
Détail kit sans notice	4 rondelles plastique noir L5			
Autocollant	Ermax Sport gravé			
Emballage	Sous skin			
Hauteur	35 cm	Largeur	34 cm	Nb trous fix. 4
Options possibles	-			
Spécial	-			
Code article	65347142			

Service qualité - 27/09/2022



FICHE PRODUIT ERMAX

HONDA

125/350 FORZA 2021 - PB SPORT



Consignes de finition - Description du produit

Sérigraphie	Oui <input type="checkbox"/>	Non <input checked="" type="checkbox"/>	Peinte	<input type="checkbox"/>
Joint	Oui <input type="checkbox"/>	Non <input checked="" type="checkbox"/>		
Kit fixation	Oui <input type="checkbox"/>	Non <input checked="" type="checkbox"/>	Sans notice	<input type="checkbox"/>
Détail kit sans notice	-			
Autocollant	Ermax			
Emballage	1 sac mousse + 1 sac transparent			
Hauteur	38,5 cm	Largeur	39,5 cm	Nb trous fix. 4
Options possibles	Sérigraphies décoratives			
Spécial				
Code article	65347143			

Service qualité - 22/01/2021



FICHE PRODUIT ERMAX

HONDA

125/350 FORZA 2021 - PB SPORT



Consignes de finition - Description du produit

Sérigraphie	Oui <input type="checkbox"/>	Non <input checked="" type="checkbox"/>	Peinte	<input type="checkbox"/>
Joint	Oui <input type="checkbox"/>	Non <input checked="" type="checkbox"/>		
Kit fixation	Oui <input type="checkbox"/>	Non <input checked="" type="checkbox"/>	Sans notice	<input type="checkbox"/>
Détail kit sans notice	-			
Autocollant	Ermax			
Emballage	1 sac mousse + 1 sac transparent			
Hauteur	38,5 cm	Largeur	39,5 cm	Nb trous fix. 4
Options possibles	Sérigraphies décoratives			
Spécial				
Code article	65347144			

Service qualité - 22/01/2021



FICHE PRODUIT ERMAX

HONDA

FORZA 750 2021 - PARE BRISE SPORT

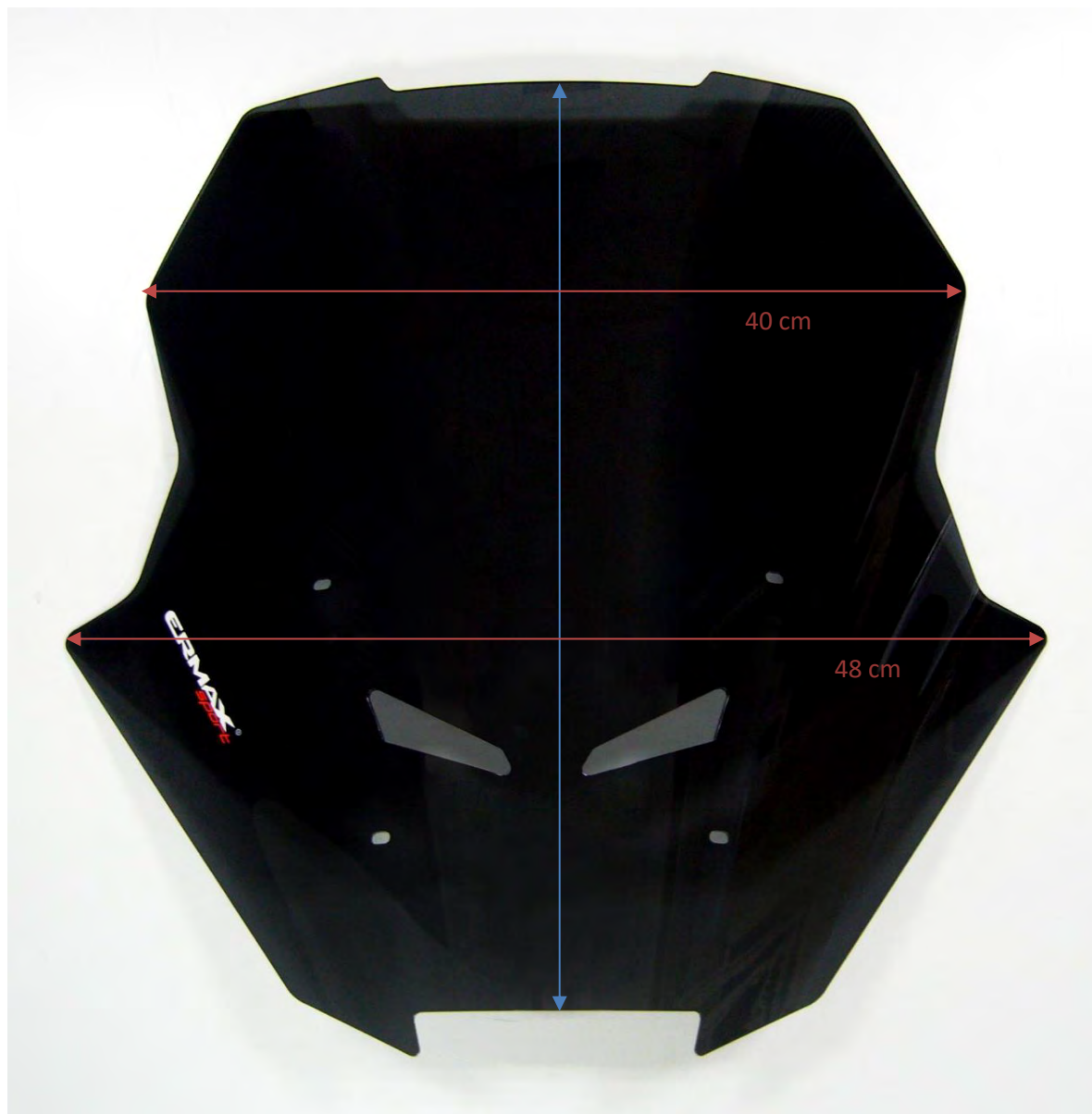

Consignes de finition - Description du produit

Sérigraphie	Oui <input type="checkbox"/>	Non <input checked="" type="checkbox"/>	Peinte	<input type="checkbox"/>
Joint	Oui <input type="checkbox"/>	Non <input checked="" type="checkbox"/>		
Kit fixation	Oui <input type="checkbox"/>	Non <input checked="" type="checkbox"/>	Sans notice	<input type="checkbox"/>
Détail kit sans notice	-			
Autocollant	Ermax			
Emballage	1 sac mousse + 1 sac transparent			
Hauteur	48 cm	Largeur	48 cm	Nb trous fix. 4
Options possibles	Sérigraphies décoratives			
Spécial				
Code article	65347145			

Service qualité - 01/02/2021



FICHE PRODUIT ERMAX

KYMCO

DTX 360 2022 - PARE BRISE SPORT

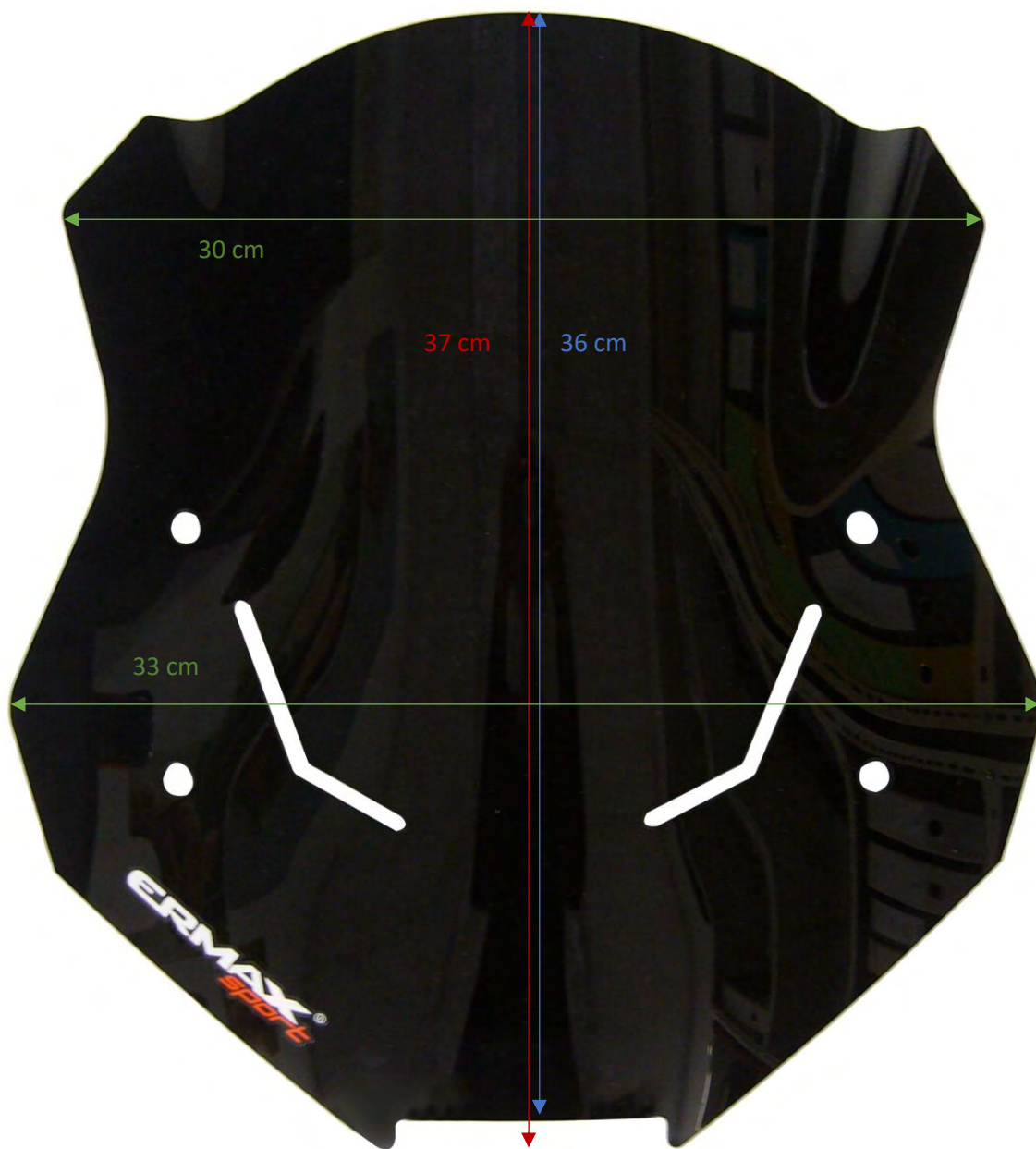

Consignes de finition - Description du produit

Sérigraphie	Oui <input type="checkbox"/>	Non <input checked="" type="checkbox"/>	Peinte	<input type="checkbox"/>
Joint	Oui <input type="checkbox"/>	Non <input checked="" type="checkbox"/>		
Kit fixation	Oui <input type="checkbox"/>	Non <input type="checkbox"/>	Sans notice	<input checked="" type="checkbox"/>
Détail kit sans notice	4 silent blocks SANS les entretoises métalliques			
Autocollant	Ermax			
Emballage	1 sac mousse + 1 sac transparent			
Hauteur	37 cm	Largeur	33 cm	Nb trous fix. 4
Options possibles	Sérigraphies décoratives			
Spécial				
Code article	65347147			

Service qualité - 05/10/2022



FICHE PRODUIT ERMAX

PIAGGIO

MP3 400/530 HPE 2022 - PB SPORT

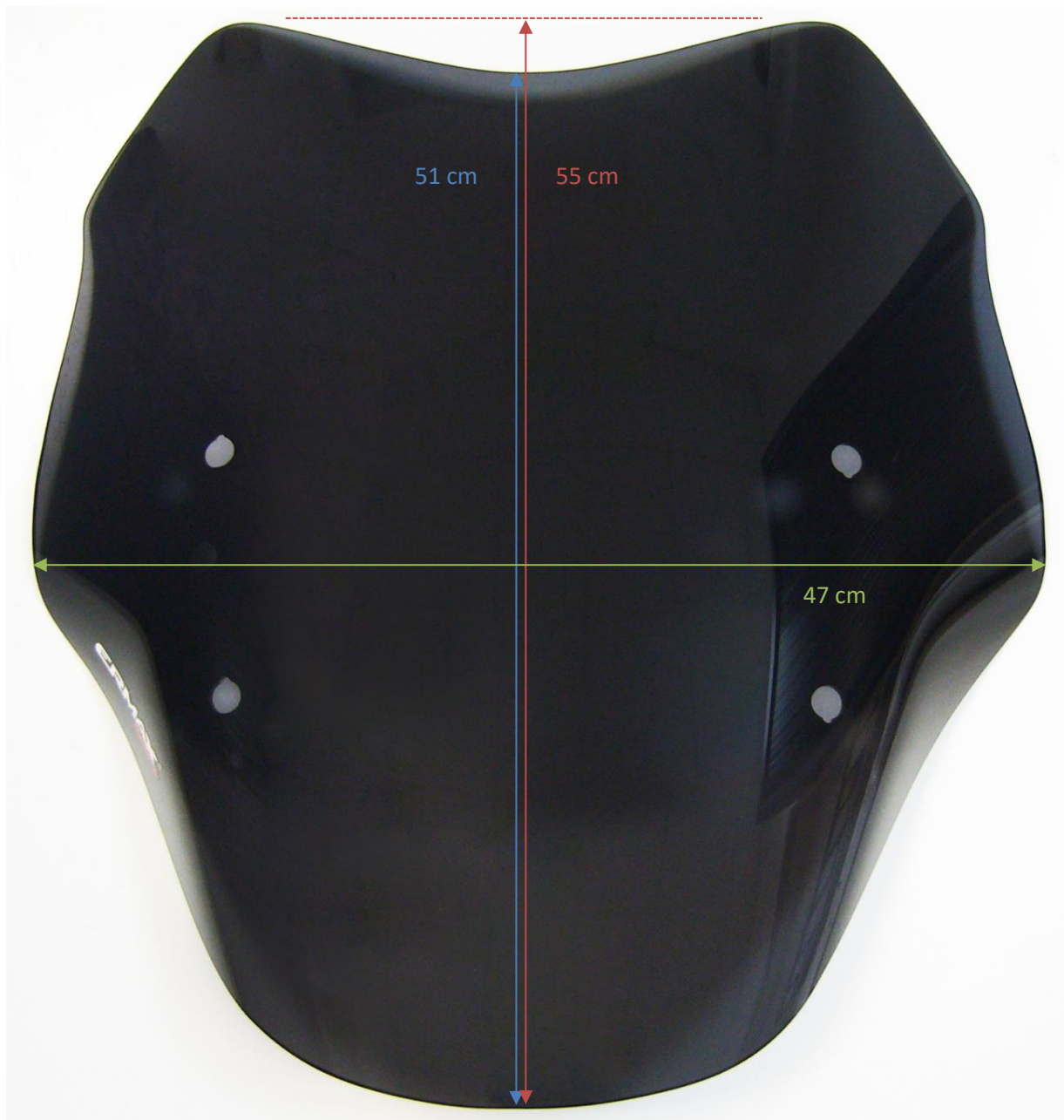

Consignes de finition - Description du produit

Sérigraphie	Oui <input type="checkbox"/>	Non <input checked="" type="checkbox"/>	Peinte	<input type="checkbox"/>
Joint	Oui <input type="checkbox"/>	Non <input checked="" type="checkbox"/>		
Kit fixation	Oui <input type="checkbox"/>	Non <input checked="" type="checkbox"/>	Sans notice	<input type="checkbox"/>
Détail kit sans notice	-			
Autocollant	Ermax			
Emballage	1 sac mousse + 1 sac transparent			
Hauteur	51 cm	Largeur	47 cm	Nb trous fix. 4
Options possibles	Sérigraphies décoratives			
Spécial				
Code article	65347149			

Service qualité - 15/11/2022



FICHE PRODUIT ERMAX

SYM

CRUISYM 2022 - PB SPORT

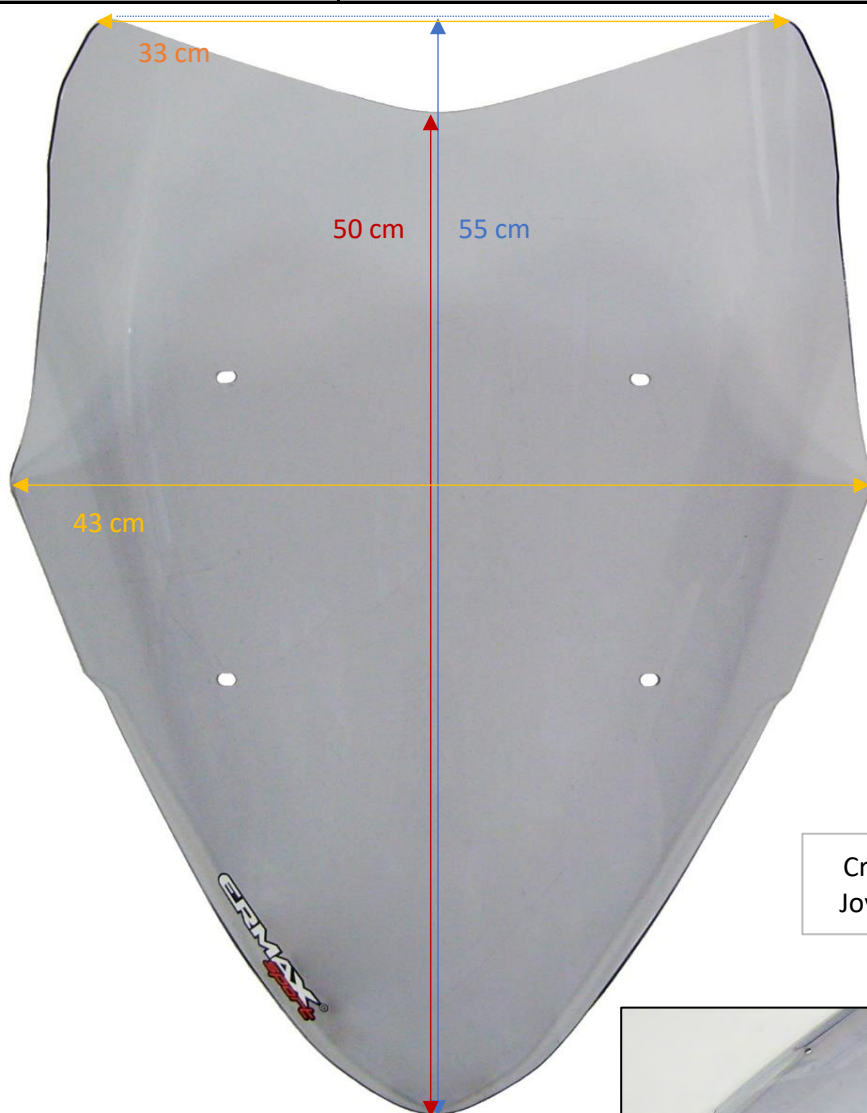

Pattes de fixation

Cruisym 2022 : trous oblongs
Joymax Z + 2022 : trous ronds



Consignes de finition - Description du produit

Sérigraphie	Oui <input type="checkbox"/>	Non <input checked="" type="checkbox"/>	Peinte	<input type="checkbox"/>
Joint	Oui <input type="checkbox"/>	Non <input checked="" type="checkbox"/>		
Kit fixation	Oui <input checked="" type="checkbox"/>	Non <input type="checkbox"/>	Sans notice	<input type="checkbox"/>
Détail kit sans notice	-			
Autocollant	Ermax			
Emballage	1 sac mousse + 1 sac transparent			
Hauteur	55 cm	Largeur	43 cm	Nb trous fix. 4
Options possibles	Sérigraphies décoratives			
Spécial				
Code article	65347150			

Service qualité - 03/10/2022



FICHE PRODUIT ERMAX

SYM

JOYMAX Z + 2022 - PB SPORT



Pattes de fixation



Consignes de finition - Description du produit

Sérigraphie	Oui <input type="checkbox"/>	Non <input checked="" type="checkbox"/>	Peinte	<input type="checkbox"/>
Joint	Oui <input type="checkbox"/>	Non <input checked="" type="checkbox"/>		
Kit fixation	Oui <input checked="" type="checkbox"/>	Non <input type="checkbox"/>	Sans notice	<input type="checkbox"/>
Détail kit sans notice	-			
Autocollant	Ermax			
Emballage	1 sac mousse + 1 sac transparent			
Hauteur	55 cm	Largeur	43 cm	Nb trous fix. 4
Options possibles	Sérigraphies décoratives			
Spécial				
Code article	65347151			

Service qualité - 15/11/2022



FICHE PRODUIT ERMAX

YAMAHA

T MAX 560 2022 - PARE BRISE SPORT

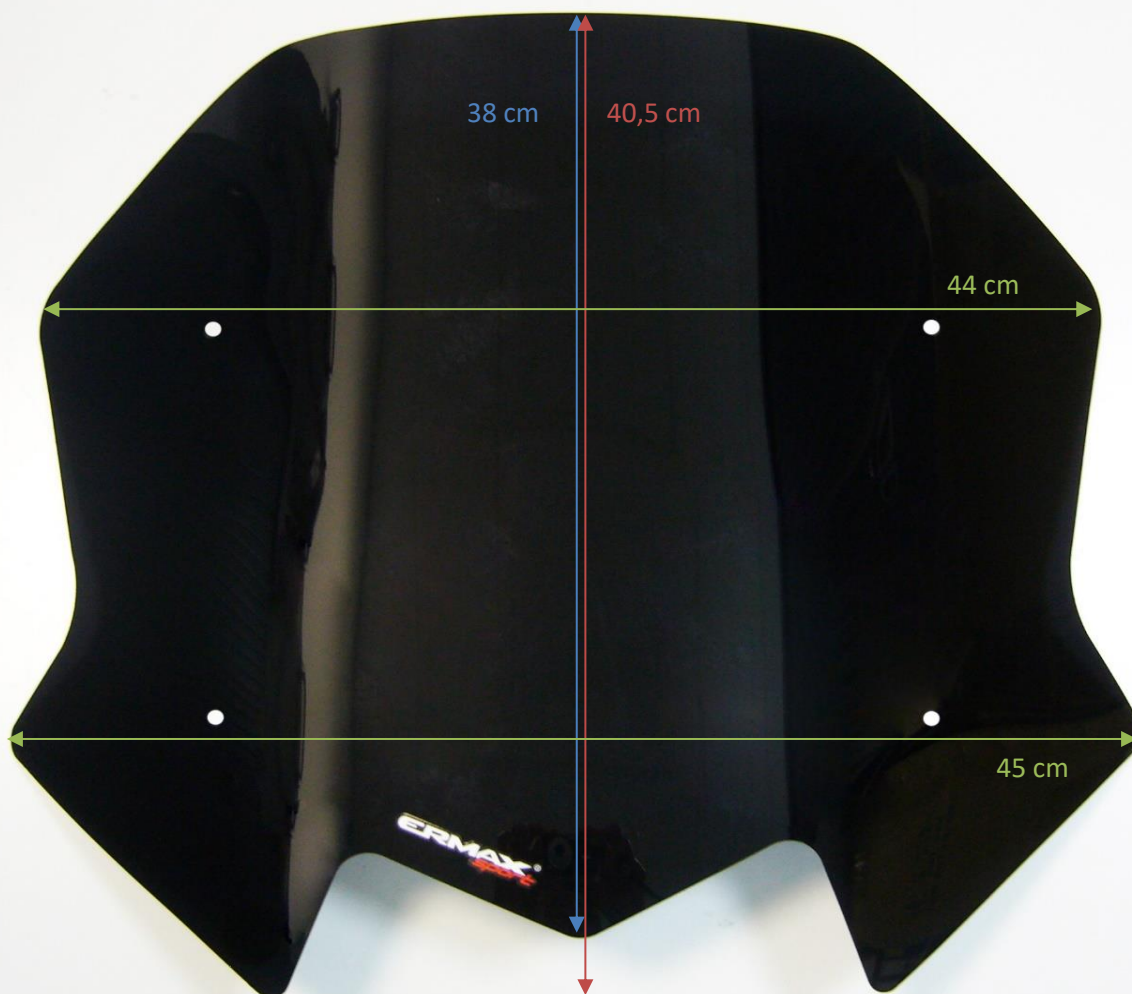

Consignes de finition - Description du produit

Sérigraphie	Oui <input type="checkbox"/>	Non <input checked="" type="checkbox"/>	Peinte	<input type="checkbox"/>
Joint	Oui <input type="checkbox"/>	Non <input checked="" type="checkbox"/>		
Kit fixation	Oui <input type="checkbox"/>	Non <input checked="" type="checkbox"/>	Sans notice	<input type="checkbox"/>
Détail kit sans notice	-			
Autocollant	Ermax			
Emballage	1 sac mousse + 1 sac transparent			
Hauteur	40,5 cm	Largeur	45 cm	Nb trous fix. 4
Options possibles	Sérigraphies décoratives			
Spécial				
Code article	65347152			

Service qualité - 30/06/2022

MONTAGEANLEITUNG



Artikel-Bezeichnung:
Ermax
Windschilder/Cockpitscheiben
für Roller/Scooter/Maxi-Scooter

Bestellnummer:
653470..

1. Montageanleitung für Verkleidungsscheiben:

- Der Anbau erfolgt im Austausch für die Originalscheibe, an den Original-Aufnahmepunkten, mittels der Original-Befestigungsschrauben.

2. Montageanleitung für Windschilder:

- Stellen Sie Ihren Roller/Scooter sicher und stabil ab.
- Überprüfen Sie, ob Sie den richtigen Montagesatz für Ihren Roller/Scooter haben
- Befestigen Sie vorsichtig den Haltersatz an Ihrem Roller/Scooter. Ziehen Sie die Schrauben nicht vollständig fest
- Montieren Sie die Scheibe an Ihren Roller/Scooter.
- Stellen Sie sicher, dass die Blinker nicht von der Scheibe verdeckt werden.
- Stellen Sie die Scheibe so ein, dass sie oberhalb des Scheinwerfers abschließt.
- Eventuell entfernte Anbauteile bitte wieder montieren.
- Wenn die Scheibe ohne Spannung sitzt, die Schrauben vorsichtig von innen nach außen fest anziehen.

**Achtung!
Wichtiger
Montagehinweis**

- Bei zu fester Verschraubung besteht Materialbruchgefahr

**Stand:
15.11.2022**

Bitte beachten Sie, dass wir uns technische Änderungen vorbehalten.